

Customer guidance systems

Setting trends worldwide





Contents

CONTENTS	3	04 BARRIERS	90
OVER 50 YEARS OF CUSTOMER GUIDANCE SYSTEMS	5	Emergency exits	
A BRILLIANT RECEPTION	7	⁰¹ N exit.....	92
THE GUIDANCE YOUR CUSTOMERS NEED	8	⁰² N exit 1400/2000.....	94
SAFETY AS YOU NEED IT	9	Pallet passages	
PROJECT PLANNING, WITH A GREAT DEAL OF EXPERIENCE	10	⁰³ Motor-driven pallet passage.....	96
SERVICE, AT ANY TIME AND IN ANY LOCATION	11	⁰⁴ Mechanical pallet passage.....	98
OVERVIEW OF THE MARKET	12	Mechanical checkout barriers	
01 ENTRANCE SYSTEMS	14	⁰⁵ Classic checkout barrier.....	100
Electronic entrance systems		⁰⁶ Tandem checkout barrier.....	104
⁰¹ eGate Colour.....	16	⁰⁷ RP/RPS checkout barrier.....	106
⁰² eGate.....	20	⁰⁸ S and FS checkout barriers.....	108
⁰³ Technoport.....	24	⁰⁹ Security checkout barrier.....	112
⁰⁴ Transponder module.....	28	Electronic checkout barriers/swing gates	
⁰⁵ Ecoport.....	30	¹⁰ mGate.....	114
⁰⁶ Entrance box.....	35	¹¹ eGate Checkout.....	120
Mechanical entrance systems		¹² Checkout Manager PRO.....	123
⁰⁷ Safety turnstiles.....	38	05 EXITGATES	128
⁰⁸ Swing gates.....	41	ExitGates	
02 GUIDANCE SYSTEMS	44	⁰¹ eGate Colour and eGate systems.....	130
Customer guidance systems		⁰¹ Technoport system	130
⁰¹ Railix Colour partition system.....	46	06 CUSTOMER COUNTING	134
⁰² Railix Design partition system.....	50	Software	
⁰³ Railix Security partition system.....	54	⁰¹ WCC customer counter.....	136
⁰⁴ Railix Basic partition system.....	58	⁰² Length of stay calculation.....	137
⁰⁵ Classic partition system.....	62	Customer frequency measurement	
⁰⁶ Classic customer guidance system.....	66	⁰³ with 2D cam	138
03 PROTECTION SYSTEMS	70	⁰⁴ with direction-sensing radar.....	140
Ram protection systems		⁰⁵ with light barrier.....	141
⁰¹ Classic guide rails.....	72	Customer counting	
⁰² Technoline guide rails.....	74	⁰⁶ with light barrier.....	142
⁰³ Stainless steel guide rails	76	WENI-Control network module.....	143
⁰⁴ NX stainless steel guide rails.....	78	07 SERVICE	144
⁰⁵ Ram protection hoops.....	80	Electrical installation.....	146
⁰⁶ Protec 3 bumper.....	82	⁰¹ eGate Colour / eGate / ExitGate.....	147
⁰⁷ Bumper for freezer units.....	84	⁰² Technoport / ExitGate.....	148
⁰⁸ Chrome or aluminium corner protector.....	86	⁰³ Ecoport.....	149
⁰⁹ Protectors for security tags.....	87	⁰⁴ Checkout Manager PRO.....	150
¹⁰ Ram protection uprights/bollards.....	88	Accessories	
¹¹ Deflector rings	89	⁰⁵ Swivel range monitoring.....	152
		⁰⁶ Individual components.....	153
		⁰⁷ Fixing material.....	154
		⁰⁸ Special bases.....	155

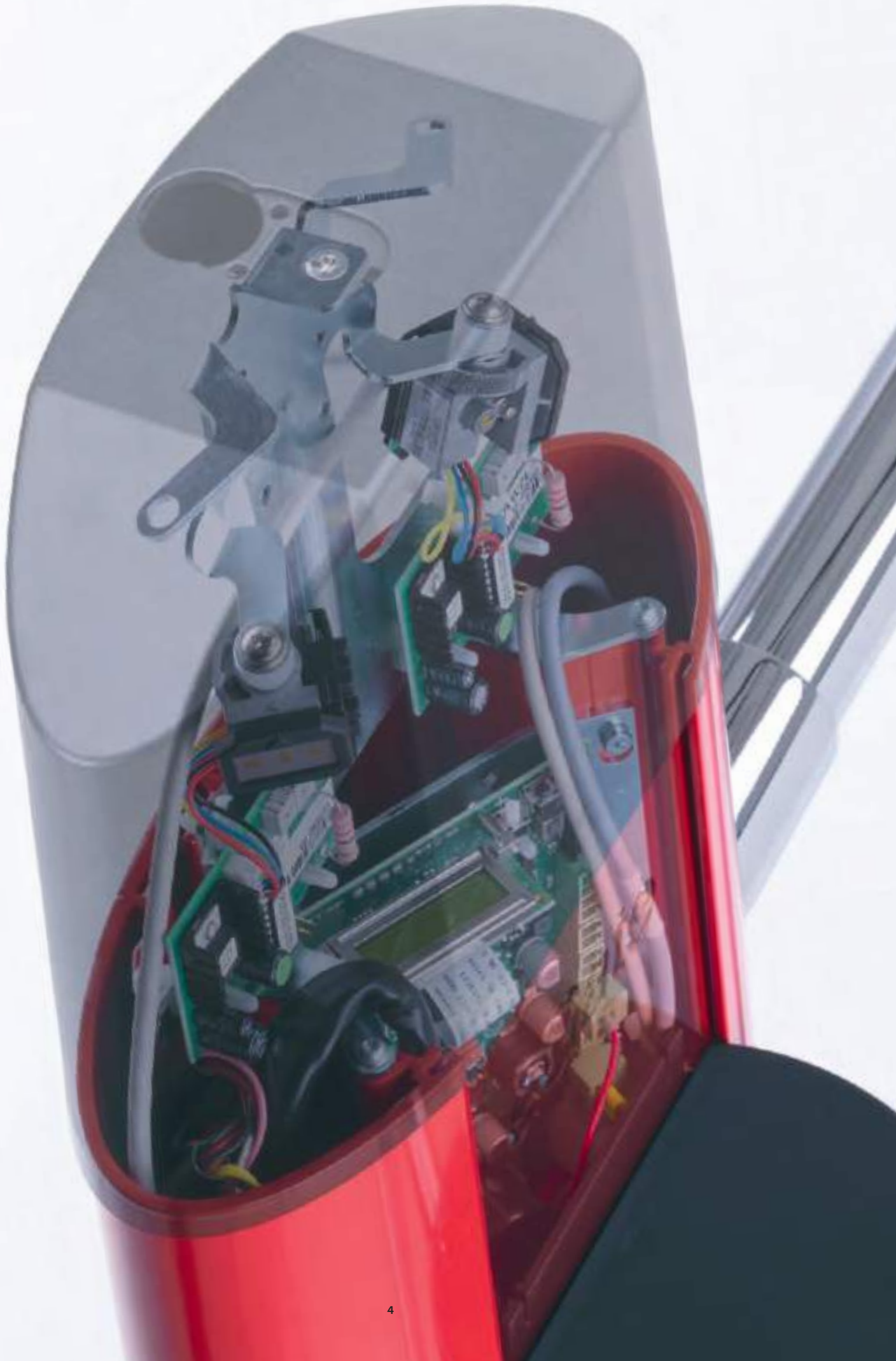

Over 50 years of customer guidance systems

Benefit from Wanzl knowledge and expertise



CATALOGUE FROM 1966

■ **For over 50 years**, entrance systems and turnstiles, customer guidance systems and barriers have been a focal point of the Wanzl product range. Wherever it is necessary to manage and monitor routes and to guarantee a seamless process, the innovative and high-quality products from Wanzl are in use.



PORTAMAT KL

■ **The Wanzl customer guidance portfolio is systematic.** It contains all the components that modern stores require to guide and regulate customer flows, from the entrance to the checkout. Electronic and mechanical entrance systems for control at the entrances, guidance systems for directing the customers, protection systems for the store and furnishings, functional parts for staff, goods delivery and emergencies, elements for controlling the checkout area and the exits. They also comply with the highest safety requirements, for example in the event of emergencies or when used as anti-theft protection.



TECHNOPORT R®

The world is changing and safety devices are on the increase

■ **Wanzl** employs over 4,000 employees at eleven production sites worldwide, who work on new fields of business and products, ensuring extraordinary product design, consistently high quality and a vast production range. The result is a product that will extend Wanzl's success into the future: perfectly satisfied customers.



EGATE®



A brilliant reception

There's no second chance to make a first impression



INVITING:
Technoport



INVITING AND FUNCTIONAL:
eGate



INVITING AND EYE-CATCHING:
eGate Colour

■ **At Wanzl**, we know what people are looking for. They are looking for good experiences, not least when shopping, so inviting entry areas, low key guidance, and effective barriers from Wanzl, help achieve this goal.

■ **At Wanzl**, highly-qualified employees are constantly working to develop solutions that make the processes within your company more effective, your store more inviting, orientation easier and the process of making a purchase faster and more reliable. The ability to avoid inventory differentials from the outset saves annoyance on both sides. The aim: perfectly satisfied customers.

■ **Wanzl products are unique.** Wanzl's specialist competence, consistency, reliability and innovative solutions and technologies ensure effective work processes – and thus also the competitiveness and business success of its partners. Exploit this opportunity and “show yourself from your best side”.

■ **Wanzl products are environmentally-friendly and sustainable.** At the manufacturing stage, Wanzl takes care to use environmentally-friendly production techniques, coupled with environmentally-friendly and recyclable materials. The products are high quality and the measures implemented for upkeep, servicing and maintenance are worthwhile and help to keep the ongoing operating costs low for the long term.

The guidance your customers need

Reliable – from the entrance to the checkout



ELECTRONIC ENTRANCE SYSTEMS:
eGate Colour



PROTECTORS:
ProTec 3 bumper



CHECKOUT BARRIERS:
FS checkout barrier

■ **Wanzl customer guidance systems** accompany your customers throughout the entire store. Entrance systems that look as open and free of barriers as possible invite people to enter the store and make your customers feel welcome. Various designs of partitions open up paths and help to divide and structure your range. Effective protectors protect the shop fittings, the sensitive freezer units and sales counters, the shelves and tables, and help to preserve value. Barriers allow authorised persons to enter or exit whilst preventing unauthorised persons from passing through. Checkout barriers open up the exit at the checkouts. Exit gates ensure that the process runs smoothly in the checkout area or at modern payment terminals and reduce inventory differentials.

■ **Wanzl products function reliably.** The best material and surface quality, outstanding processing of all components and decades of experience in design, planning, production and installation make Wanzl the ideal partner for every aspect of guiding and directing customers and visitors. In many areas, Wanzl systems have been providing reliable service for many years.

Safety as you need it

You know the situation. Wanzl has the solution.



OPEN GUIDANCE:
Classic customer guidance systems



PREVENTATIVE ANTI-THEFT PROTECTION:
Railix Design



OPTIMUM PROTECTION AGAINST INVENTORY LOSSES:
eGate double system, double-gate

■ **Diverse solutions from Wanzl.** Safety standards requirements vary hugely from region to region and nation to nation. Inner Cities, small towns, busy large towns, and country stores etc.

You are aware of the situation in your store and know what is necessary. The equipment of the components and/or of the system is selected in line with the requirements. High swivel barriers offer more protection, partitions can completely prevent people reaching through them, and visual and acoustic alarms that are triggered in the event of manipulation of electronic entrance systems can protect against inventory differentials.

■ **The right protection for every aspect** – and if a gap is discovered in spite of this, Wanzl components are compatible and replaceable, and can be adapted at any time.

■ **Wanzl products are reliable.** Wanzl offers exactly the right solution for the various safety requirements, ranging from open-space solutions through to highly effective devices to prevent theft from stores situated in difficult areas. Take advantage of our knowledge and expertise.



Project planning, with a great deal of experience

Guiding customers – tactfully and almost unnoticeably



COMPETENT ADVICE:
on site or at our exhibit in the CreativeCenter



PROFESSIONAL PLANNING:
using modern CAD systems



3D IMAGES:
clearly show you how to use the device

■ **Competent advice.** Make contact with us at the outset. We can provide you with support and advice, even while you are first considering a new project. With our many years of experience, we will be happy to help you to approach your construction project in the best possible way and to avoid any problems. The objective: The less customers are aware that they are being steered, the more likely they are to return. An effective guidance system does not create barriers, but instead leads the way in the optimum manner.

■ **State-of-the-art 3D planning.** We create precise schematic drawings using modern, computer-based CAD systems. At every stage of the process, 3D depictions can be used to provide you with information on how the space will be used. The plans are discussed and finely tuned in detail, taking all the structural conditions into account.

■ **Wanzl - your partner from beginning to completion.** With a multitude of products making up our customer guidance range, and many years of experience, we will support you in realising your construction project, all the way from initial contact through to field assembly and installation. You will be won over by the ideas for the format and the professional project service.

Service, at any time and in any location

Assembly, maintenance and repair by experts



ASSEMBLY:
by our trained specialists



MAINTENANCE:
in line with a cycle, or as you wish



REPAIR:
with short response times

■ **Installation** exactly in line with the plan in every respect. Our experienced fitters assemble and install the systems, commission them and hand them over in ready-to-use condition – with some useful tips. This takes place exactly as planned in the drawings and, so as to comply with and not to disrupt operational processes, exactly in line with the schedule.

■ **Maintenance.** To maintain the Wanzl quality we recommend regular maintenance of all components. Ongoing maintenance ensures that the value of your investment is preserved. Ask for your own personalised maintenance plan.

■ **Repair.** An experienced team of specialists offers you short response times, a professional after-sales service and simple handling of all service requirements – nationwide. Tell us what we can do for you and we will be happy to help.

■ **Wanzl hotline** for almost all situations and available practically around the clock. You can contact our hotline during normal business hours. If attempts to resolve the fault over the telephone are unsuccessful, a member of our service team will immediately come out to your premises. There is a service support centre close to you.

Your direct line to us: See www.wanzl.com





- ❶ eGate electronic entrance system
- ❷ Railix Basic partition system with Technoline guide rails
- ❸ Chrome corner protectors
- ❹ Technoline guide rails
- ❺ N exit barrier
- ❻ Classic checkout barrier with base
- ❼ Classic checkout barrier between connecting tubes



01 Entrance systems

02 Guidance systems

03 Protection systems

04 Barriers

05 Exit gates

06 Customer counting

07 Service

01 Product overview

01.01 - 01.03 eGate and Technoport electronic entrance systems



01.04 Transponder module for eGate and Technoport



01.05 Ecoport electronic entrance systems



01.06 Entrance box



01.07 Mechanical entrance systems, safety turnstiles



01.08 Mechanical entrance systems, swing gates

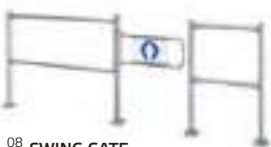

01 Entrance systems



01.01 eGate® Colour

The particularly friendly welcome

- > Friendly customer reception with LED lighting
- > Inviting route guidance in a modern design
- > Customisation with own logo or lettering available

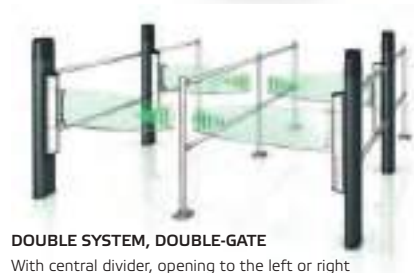

01.01 eGate® Colour

■ **eGate® Colour makes customers feel very welcome as soon as they reach the entrance area.** Innovative LED lighting clearly indicates the route and invites customers to enter the store.

Attractive eye-catching design

Thanks to the range of colour options available, the upright of the attractive high-tech entrance system matches the store's corporate design and, with the illuminated swivel arm, encourages customers to enter, with the 'barrier-effect' greatly reduced. The barrier effect is greatly reduced.

Strong system

eGate® and Railix® Colour entrance systems and partitions constitute the ideal system for a modern, visually appealing division of space.



Function

The swivel arm, lit up in **green**, unmistakably shows customers the route into the store.

Unauthorised exit from the store is prevented by the exit alarm. The light on the swivel arm changes to **red**. For a more detailed description of operation, please refer to the "eGate" section on page 23.

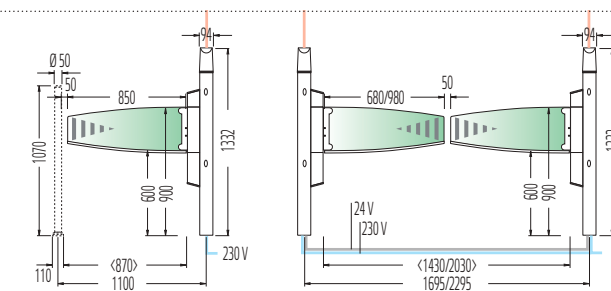
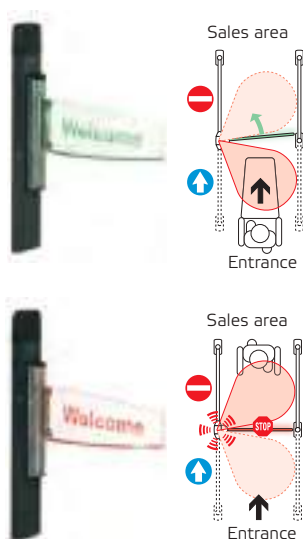

Swivel arm

Glass swivel arm as standard. Safety glass with polished edges, LED lighting and directional arrows.



Unique design

In addition to the standard designs, the illuminated swivel arm can also be personalised with your store name or logo on request.



Standard technical equipment

- Max. operating voltage of 24 V DC for the highest levels of safety.
- eGate systems comply with both national and international safety requirements.
- Even opening of swivel barriers. No swing back. Best positioning globally.
- Synchronised opening of the swivel barrier in all double systems without a central divider.
- Infinitely variable opening angle from 0° - 180°. Precise adjustment using the teach-in procedure.
- Freely programmable opening time, the system then closes again automatically.
- Direction of opening can be adjusted on-site.
- Electronically adjustable panic force.

Anti-panic features

- In an emergency, the barrier can be opened in both directions. An acoustic alarm indicates that the barrier has been opened and protects against misuse.
- The automatic barrier reset ensures that the system is ready for operation once again.

01.01 eGate® Colour – the illuminated entrance

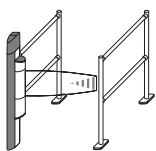
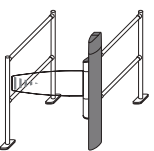
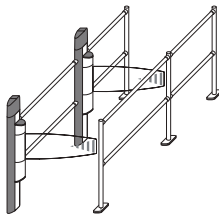
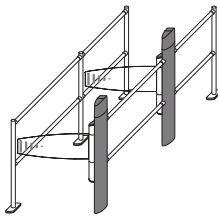
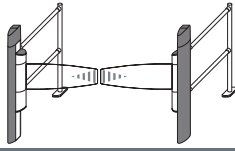
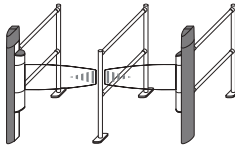
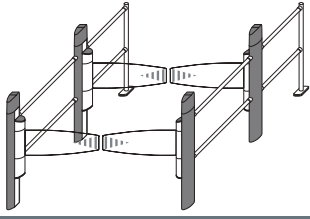
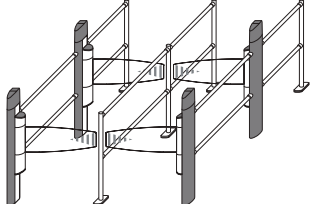
eGate single systems	Opening to the left	Opening to the right
Prod.No.	23.57093.10/73/09-7016*	23.57094.10/73/09-7016*
eGate upright without swivel arm (see right for swivel arms) Restriction base Exit section		
eGate single systems	Opening to the left, double-gate	Opening to the right, double-gate
Prod.No.	23.57097.10/73/09-7016*	23.57098.10/73/09-7016*
2 eGate uprights without swivel arms (see right for swivel arms) 2 restriction bases Intermediate section Exit section		
eGate double system	Opening in both directions	
Prod.No.	23.57096.10/73/09-7016*	
2 eGate uprights without swivel arms (see right for swivel arms) Exit section		
eGate double system	Opening to the left or right, with central divider	
Prod.No.	23.57095.10/73/09-7016*	
2 eGate uprights without swivel arms (see right for swivel arms) Exit section Central divider		
eGate double system	Opening in both directions, double-gate	
Prod.No.	23.82860.10/73/09-7016*	
4 eGate uprights without swivel arms (see right for swivel arms) Intermediate section Exit section		
eGate double system	Opening to the left or right with central divider, double-gate	
Prod.No.	23.71452.10/73/09-7016*	
4 eGate uprights without swivel arms (see right for swivel arms) Intermediate section Exit section Central divider		

ESG safety glass swivel arm as standard		
	Prod.No.	Prod.No.
Length	Opening to the left	Opening to the right
		
680 mm	23.20037.00-0001	23.20038.00-0001
850 mm	23.20034.00-0001	23.20033.00-0001
980 mm	23.20035.00-0001	23.20036.00-0001

Individual swivel arms



* Example orders:
 23.10652.10-7016 with high-gloss chrome-plated swivel mechanism
 23.10652.73-7016 with plastic powder-coated pivot mechanism, please state colour required.
 23.10652.09-7016 with stainless steel swivel mechanism
 The eGate uprights are plastic powder-coated in anthracite grey, RAL7016, as standard. Other colours available upon request.

01.01 eGate® Colour – optional equipment

Power supply from the ceiling

Single system Prod.No.	77.86815.10/73/09-0000*
Double system Prod.No.	23.51775.10/73/09-0000*

230 V feed line and signal line from the ceiling mean that no structural work is necessary and simplify alterations.

Connecting cables for cross connections on single systems

4 m	Prod.No. 98.74380.00	22 m	Prod.No. 98.74491.00
10 m	Prod.No. 98.74490.00	28 m	Prod.No. 98.74493.00
16 m	Prod.No. 98.74473.00		

Connecting cables for cross connections on double systems

10 m	Standard supply
------	-----------------



Control panel

Prod.No.	98.74269.00
----------	-------------

Passage release for one person using a button, set to permanently open with switch and passage of staff in the opposite direction using a button.



Exit alarm

	Acoustic	With voice output
Prod.No.	Standard	77.73707.95

The direction-sensing radar triggers an acoustic alarm or a voice output.

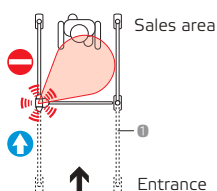

Tandem radar

Prod.No.	77.73481.95
----------	-------------

For narrow and problematic entry zones.

The second radar detects customers who approach from an acute angle. Both radar beams can be adjusted individually to suit the relevant situation. A second radar module can also be retrofitted.

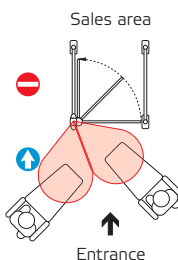

Customer frequency measurement

Prod.No.	See page 140
----------	--------------

The integrated radar modules measure the customer frequency and transmit this data to a PC. The data enable:

- Personnel management with targeted occupancy of checkouts and serving counters
- Person frequency measurement
- Benchmarking of different stores
- Success monitoring of marketing measures

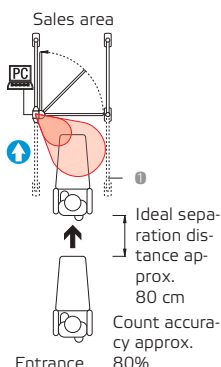

Digital counter

Prod.No.	98.73883.00
----------	-------------

Counts customers using direction-sensing radar, output via digital display. Factory-set radar sensitivity enables the highest possible count accuracy.



Radio remote control

Prod.No.	98.73693.00
----------	-------------

Remote control of one or more systems. Release in the direction of passage, exit direction or set to permanently open.



Barrier manipulation alarm

Prod.No.	98.74566.00-0000
----------	------------------

If the barrier is deliberately manipulated during the closing process, this triggers an acoustic alarm.

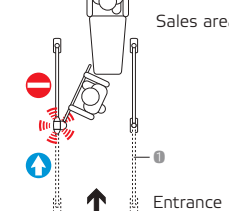

Colour-change function

Prod.No.	On request
----------	------------

For the unauthorised exit or barrier manipulation alarm

Swivel range monitoring

Prod.No.	See page 152
----------	--------------

The swivel range monitoring protects persons, and especially children, from possible injuries. In the exit section, integrated light barriers detect obstacles in the swinging area and stop the movement of the swivel barrier.

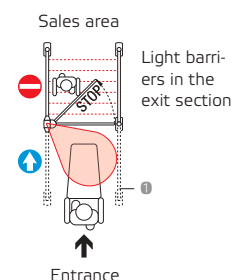

Fire alarm system

Prod.No.	On request
----------	------------

eGate systems can be integrated into the facility management system. In emergencies, the swivel barrier opens automatically in the direction of the exit.

Note:
For normally open/normally closed contact
If fire alarm systems are to be connected with normally closed contact, no control panel, button, remote control can be connected for the opening.

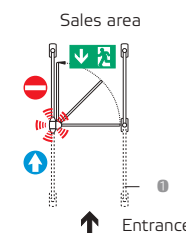

* See page 18 for example order.

① Entry section on request

01.02 eGate®

The starting point for sales success

- > Intelligent sensors and multifunctional high-tech equipment
- > Anti-panic feature with acoustic alarm and automatic barrier reset
- > Combat inventory differentials efficiently



DOUBLE SYSTEM
ES glass swivel arms, opening in both directions
Individually labelled



SINGLE SYSTEM, DOUBLE-GATE
Classic swivel barrier, opening to the left



DOUBLE SYSTEM, DOUBLE-GATE WITH ENTRY SECTION
Promotion swivel barrier, opening in both directions

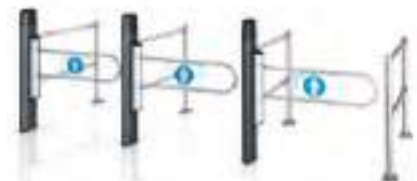

3 SINGLE SYSTEMS
Classic swivel barrier, opening to the left

01.02 eGate®

■ **eGate entrance systems.** Cutting-edge technology with many functions for guiding streams of customers. The highest standard of safety and security to protect customers and to guard against inventory differentials.

Design

Aluminium upright, coloured plastic powder-coated finish*. Housing for pivot mechanism and Classic swivel barrier with high-gloss chrome plating, coloured plastic powder-coated finish* or in stainless steel. Sign made of white plastic or transparent acrylic glass, printed on both sides.

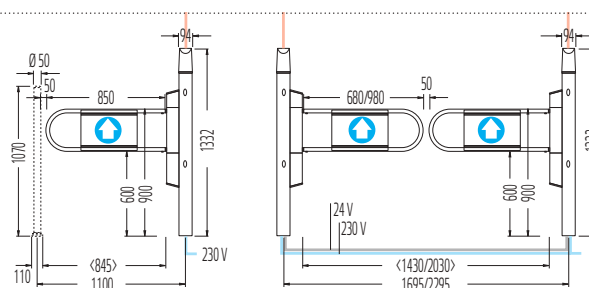

Function

eGate entrance systems are equipped with a radar control as a standard feature. In the case of double-gate systems, the second system is controlled by an infrared light barrier. The radar control saves space, as in most cases it is possible to dispense with an entry section ❶.

Adjustable radar beam

The range can be set to suit the space available and the opening time can be adjusted from 0.5 up to a maximum of 2.5 m.

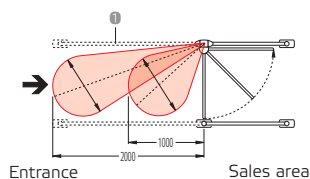

Standard technical equipment

- Max. operating voltage of 24 V DC for the highest levels of safety.
- eGate systems comply with both national and international safety requirements.
- Even opening of swivel barriers. No swing back. Best positioning globally.
- Synchronised opening of the swivel barrier in all double systems without a central divider.
- Infinitely variable opening angle from 0° - 180°. Precise adjustment using the teach-in procedure.
- Freely programmable opening time, the system then closes again automatically.
- Direction of opening can be adjusted on-site.
- Electronically adjustable panic force.

Radar control – system examples

Single systems
With radar control

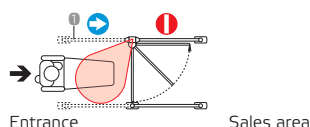

Double systems
Radar control of both uprights

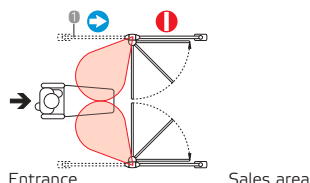

Double-gate systems
Radar control of the first upright and control of the second upright by means of a light barrier in the first upright.

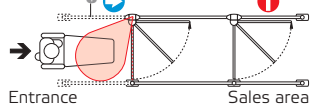

Anti-panic features

- In an emergency, the barrier can be opened in both directions. An acoustic alarm indicates that the barrier has been opened and protects against misuse.
- The automatic barrier reset ensures that the system is ready for operation once again.

Swivel barrier

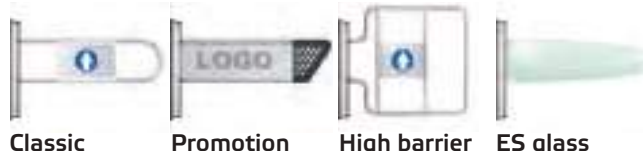

* Different colours available upon request.

01.02 eGate® – precisely tailor-made

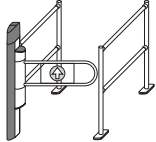
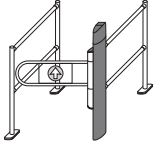
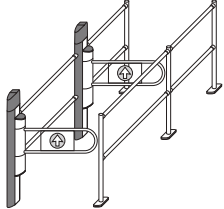
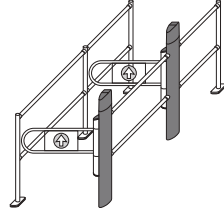
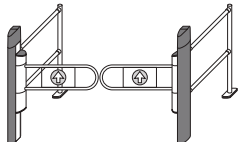
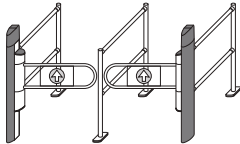
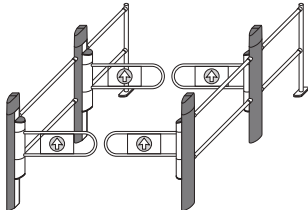
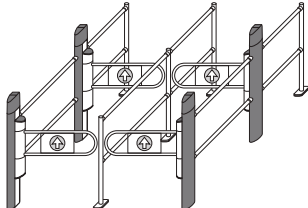
eGate single systems	Opening to the left	Opening to the right
for swivel barriers	23.16406.10/73/09-0001*	23.16519.10/73/09-0001*
for swivel arm made from ESG safety glass	23.31322.10/73/09-0001*	23.31548.10/73/09-0001*
eGate upright without swivel barrier/arm**		
Restriction base		
Exit section		
eGate single systems	Opening to the left, double-gate	Opening to the right, double-gate
for swivel barriers	23.16858.10/73/09-0001*	23.16971.10/73/09-0001*
for swivel arm made from ESG safety glass	23.31774.10/73/09-0001*	23.32226.10/73/09-0001*
2 eGate uprights without swivel barriers/arms**		
2 restriction bases		
Intermediate section		
Exit section		
eGate double system	Opening in both directions	
for swivel barriers	23.17762.10/73/09-0001*	
for swivel arm made from ESG safety glass	23.32565.10/73/09-0001*	
2 eGate uprights without swivel barriers/arms**		
Exit section		
eGate double system	Opening to the left or right, with central divider	
for swivel barriers	23.18214.10/73/09-0001*	
for swivel arm made from ESG safety glass	23.32678.10/73/09-0001*	
2 eGate uprights without swivel barriers/arms**		
Exit section		
Central divider		
eGate double system	Opening in both directions, double-gate	
for swivel barriers	23.21039.10/73/09-0001*	
for swivel arm made from ESG safety glass	23.33017.10/73/09-0001*	
4 eGate uprights without swivel barriers/arms**		
Intermediate section		
Exit section		
eGate double system	Opening to the left or right with central divider, double-gate	
for swivel barriers	23.23073.10/73/09-0001*	
for swivel arm made from ESG safety glass	23.33130.10/73/09-0001*	
4 eGate uprights without swivel barriers/arms**		
Intermediate section		
Exit section		
Central divider		

Classic swivel barrier		
	Prod.No.	Prod.No.
Length	White sign	Transparent sign
		
Back of sign		
680 mm	23.89065.10-0000	23.38307.10-0000
850 mm	23.72235.10-0000	23.38194.10-0000
980 mm	23.53583.10-0000	23.38420.10-0000

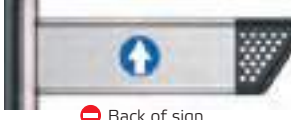
Promotion swivel barrier		
	Prod.No.	Prod.No.
Length	White sign	Transparent sign
		
Back of sign		
Barrier	for single systems	
680 mm	23.50100.10-7016	23.50101.10-7016
850 mm	23.50102.10-7016	23.50103.10-7016
980 mm	23.50104.10-7016	23.50105.10-7016
DGB	for double systems	
1400 mm	23.50108.10-7016	23.50109.10-7016
1740 mm	23.50110.10-7016	23.50111.10-7016
2000 mm	23.50112.10-7016	23.50113.10-7016

DGB = access width

High swivel barrier		
	Prod.No.	Prod.No.
Length	White sign	Transparent sign
		
Swivel barrier extendable by 300 mm		
Back of sign		
630 to 930 mm	23.29498.10-0004	23.29498.10-0002

ESG safety glass swivel arm as standard		
	Prod.No.	Prod.No.
Length	Opening to the left	Opening to the right
		
680 mm	23.68041.00-0001	23.68042.00-0001
850 mm	23.20582.00-0001	23.20581.00-0001
980 mm	23.20695.00-0001	23.20696.00-0001

* See page 18 for example order. ** See right for swivel barriers/arms

01.02 eGate® – optional equipment

Power supply from the ceiling

Single system Prod.No.	77.86815.10/73/09-0000*
Double system Prod.No.	23.51775.10/73/09-0000*

230 V feed line and signal line from the ceiling mean that no structural work is necessary and simplify alterations.

Connecting cables for cross connections on single systems

4 m	Prod.No. 98.74380.00	22 m	Prod.No. 98.74491.00
10 m	Prod.No. 98.74490.00	28 m	Prod.No. 98.74493.00
16 m	Prod.No. 98.74473.00		

Connecting cables for cross connections on double systems

10 m	Standard supply
------	-----------------



Control panel

Prod.No.	98.74269.00
----------	-------------

Passage release for one person using a button, set to permanently open with switch and passage of staff in the opposite direction using a button.



Exit alarm

	Acoustic	With voice output
Prod.No.	77.73594.95	77.73707.95

The direction-sensing radar triggers an acoustic alarm or a voice output.

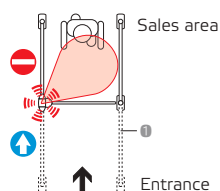

Tandem radar

Prod.No.	77.73481.95
----------	-------------

For narrow and problematic entry zones. The second radar detects customers who approach from an acute angle. Both radar beams can be adjusted individually to suit the relevant situation. A second radar module can also be retrofitted.

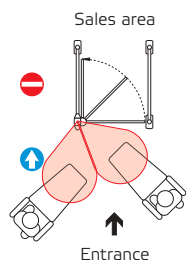

Customer frequency measurement

Prod.No.	See page 140
----------	--------------

The integrated radar modules measure the customer frequency and transmit this data to a PC. The data enable:

- Personnel management with targeted occupancy of checkouts and serving counters
- Person frequency measurement
- Benchmarking of different stores
- Success monitoring of marketing measures

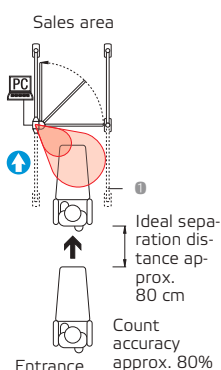

Digital counter

Prod.No.	98.73883.00
----------	-------------

Counts customers using direction-sensing radar, output via digital display. Factory-set radar sensitivity enables the highest possible count accuracy.



Radio remote control

Prod.No.	98.74469.00
----------	-------------

Remote control of one or more systems. Release in the direction of passage, exit direction or set to permanently open.



Barrier manipulation alarm

Prod.No.	98.74566.00-0000
----------	------------------

If the barrier is deliberately manipulated during the closing process, this triggers an acoustic alarm.

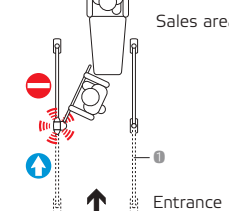

Swivel range monitoring

Prod.No.	See page 152
----------	--------------

The swivel range monitoring protects persons, and especially children, from possible injuries. In the exit section, integrated light barriers detect obstacles in the swinging area and stop the movement of the swivel barrier.

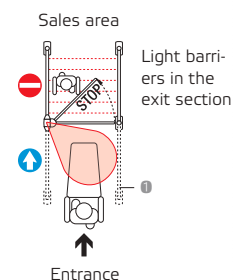

Fire alarm system

Prod.No.	On request
----------	------------

eGate systems can be integrated into the facility management system. In emergencies, the swivel barrier opens automatically in the direction of the exit.

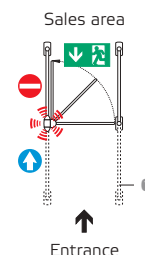

For normally open/normally closed contact
 Note:
 If fire alarm systems are to be connected with normally closed contact, no control panel, button, remote control can be connected for the opening.

* See page 18 for example order.

① Entry section on request

01.03 Technoport®

Proven entrance solutions with many functions as standard

- > *The multi-talented system to welcome customers and ensure safety*
- > *An eye-catcher with high-tech functions including radar control, light barriers and anti-panic feature*
- > *Barrier-free and can be used universally*



DOUBLE SYSTEM WITH CENTRAL DIVIDER
Classic swivel barrier, opening to the left or right



SINGLE SYSTEM, DOUBLE-GATE WITH ENTRY SECTION
Promotion swivel barrier, opening to the left



DOUBLE SYSTEM, DOUBLE-GATE, WITH CENTRAL DIVIDER
Classic swivel barrier, opening to the left or right



3 SINGLE SYSTEMS, DOUBLE-GATE
Classic swivel barrier, opening to the left

01.03 Technoport®

■ **Technoport entrance systems** from Wanzl really have something to offer for both yours and your customers' safety. A future-proof investment that will pay for itself in a very short time. Just make the comparison.

Design

Upright and Classic swivel barrier made of steel tubing, high-gloss chrome-plated or coloured plastic powder coating*. Pivot mechanism made of metal, fully integrated in the upright – provides a particularly high level of injury protection. Sign made of white plastic or transparent acrylic glass, printed on both sides.

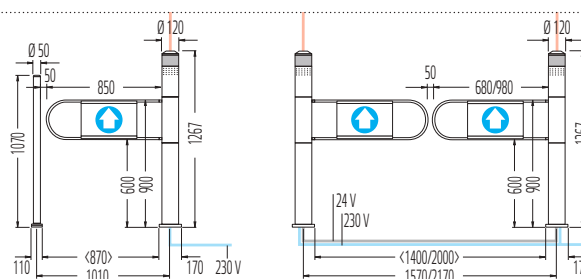

Function

Technoport entrance systems are equipped with a radar control as a standard feature. In the case of double-gate systems, the second system is controlled by an infrared light barrier. The radar control saves space, as in most cases it is possible to dispense with an entry section ❶.

Adjustable radar beam

Flexible adaptation of the radar beam for optimum customer registration and to suit the space available from 0.5 up to a maximum of 2.5 m.

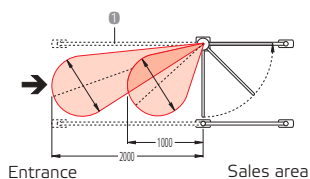

Standard technical equipment

- Max. operating voltage of 24 V DC for the highest levels of safety.
- Technoport systems comply with both national and international safety requirements.
- Even opening of swivel barriers. No swing back. Best positioning globally.
- Synchronised opening of the swivel barrier in all double systems without a central divider.
- Infinitely variable opening angle from 0° - 180°. Precise adjustment using the teach-in procedure.
- Freely programmable opening time, the system then closes again automatically.
- Direction of opening can be adjusted on-site.
- Panic alarm.

Radar control - System examples

Single systems

Radar control

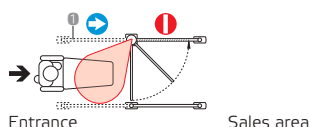

Double systems

Radar control of both uprights

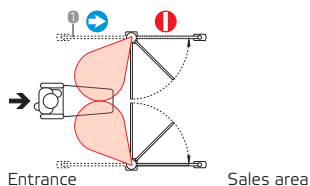

Double-gate systems

Radar control of the first upright and control of the second upright by means of a light barrier in the first upright.

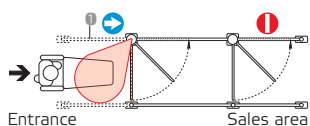

Anti-panic features

- In an emergency, the barrier can be opened in both directions. An acoustic alarm indicates that the barrier has been opened and protects against misuse.
- The automatic barrier reset ensures that the system is ready for operation once again.

Swivel barrier



* Colours and stainless steel design on request.

01.03 Technoport® – the right solution

Technoport single systems	Opening to the left	Opening to the right
Prod.No.	23.27008.10/73/09-0000*	23.26669.10/73/09-0000*
Technoport upright without swivel barrier* Restriction base Exit section		
Technoport single systems	Opening to the left, double-gate	Opening to the right, double-gate
Prod.No.	23.28929.10/73/09-0000*	23.28477.10/73/09-0000*
2 Technoport uprights without swivel barrier* 2 restriction bases Intermediate section Exit section		
Technoport double system	Opening in both directions	
Prod.No.	23.30172.10/73/09-0000*	
2 Technoport uprights without swivel barrier* Exit section		
Technoport double system	Opening to the left or right, with central divider	
Prod.No.	23.30737.10/73/09-0000*	
2 Technoport uprights without swivel barrier* Exit section Central divider		
Technoport double system	Opening in both directions, double-gate	
Prod.No.	23.31867.10/73/09-0000*	
4 Technoport uprights without swivel barrier* Intermediate section Exit section		
Technoport double system	Opening to the left or right with central divider, double-gate	
Prod.No.	23.34240.10/73/09-0000*	
4 Technoport uprights without swivel barrier* Intermediate section Exit section Central divider		

Classic swivel barrier		
	Prod.No.	Prod.No.
Length	White sign	Transparent sign
Back of sign		
680 mm	23.89065.10-0000	23.38307.10-0000
850 mm	23.72235.10-0000	23.38194.10-0000
980 mm	23.53583.10-0000	23.38420.10-0000

Promotion swivel barrier		
	Prod.No.	Prod.No.
Length	White sign	Transparent sign
Back of sign		
Barrier	for single systems	
680 mm	23.50100.10-7016	23.50101.10-7016
850 mm	23.50102.10-7016	23.50103.10-7016
980 mm	23.50104.10-7016	23.50105.10-7016
DGB	for double systems	
1400 mm	23.50108.10-7016	23.50109.10-7016
1740 mm	23.50110.10-7016	23.50111.10-7016
2000 mm	23.50112.10-7016	23.50113.10-7016

DGB = access width

* Example orders:
 23.27008.10-0000 High-gloss chrome-plated
 23.27008.73-0000 Plastic powder coating, please specify the colour required.
 23.27008.09-0000 Stainless steel

* See right for swivel barriers

01.03 Technoport® – optional equipment

Power supply from the ceiling

Single system Prod.No.	23.27237.10/73/09-0000*
Double system Prod.No.	23.22831.10/73/09-0000*

230 V feed line and signal line from the ceiling mean that no structural work is necessary and simplify alterations.

Connecting cables for cross connections on single systems

4 m	Prod.No. 98.72913.00	22 m	Prod.No. 98.73210.00
10 m	Prod.No. 98.72910.00	28 m	Prod.No. 98.73466.00
16 m	Prod.No. 98.73209.00		

Connecting cables for cross connections on double systems
10 m Standard supply



Control panel with counter

Prod.No.	98.72914.00
----------	-------------

Passage release for one person using a button, set to permanently open with switch and passage of staff in the opposite direction using a button.



Exit alarm

	Acoustic	With voice output
Prod.No.	23.72117.10	23.81473.10

The direction-sensing radar triggers an acoustic alarm or a voice output.

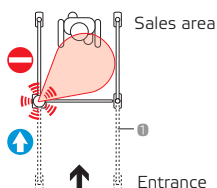

Tandem radar

Prod.No.	98.00001.00
----------	-------------

For narrow and problematic entry zones.

The second radar detects customers who approach from an acute angle. Both radar beams can be adjusted individually to suit the relevant situation. A second radar module can also be retrofitted.

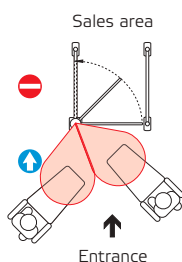

Customer frequency measurement

Prod.No.	See page 140
----------	--------------

The integrated radar modules measure the customer frequency and transmit this data to a PC. The data enable:

- Personnel management with targeted occupancy of checkouts and serving counters
- Person frequency measurement
- Benchmarking of different stores
- Success monitoring of marketing measures

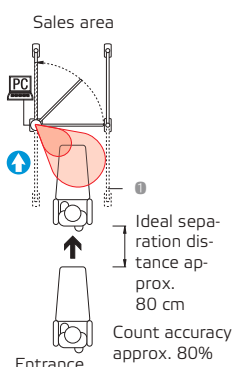

Digital counter

Prod.No.	23.72118.10
----------	-------------

Counts customers using direction-sensing radar, output via digital display. Factory-set radar sensitivity enables the highest possible count accuracy.



Radio remote control

Prod.No.	98.73693.00
----------	-------------

Remote control of one or more systems. Release in the direction of passage, exit direction or set to permanently open.



Barrier manipulation alarm

Prod.No.	98.74566.00
----------	-------------

If the barrier is deliberately manipulated during the closing process, this triggers an acoustic alarm.

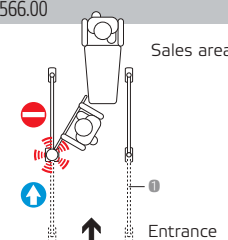

Swivel range monitoring

Prod.No.	See page 152
----------	--------------

The "barrier stop" swivel range monitoring protects persons, and especially children, from possible injuries.

In the exit section, integrated light barriers detect obstacles in the swinging area and stop the movement of the swivel barrier.

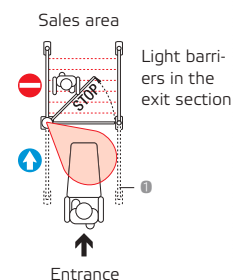

Fire alarm system

Prod.No.	On request
----------	------------

Technoport systems can be integrated into the facility management system.

In emergencies, an acoustic alarm is triggered at the entry barrier and warns the staff and the customers. The swivel barrier opens automatically in the direction of the exit and so opens up an emergency exit.

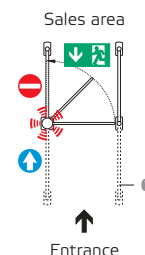

For normally open/normally closed contact
Note:
If fire alarm systems are to be connected with normally closed contact, no control panel, button, remote control can be connected for the opening.

* See page 26 for example order.

① Entry section on request

01.04 Transponder module

Free passage with transponders in the form of key rings

- > *Open the entrance system with transponders*
- > *Installation in entry or exit section depending on usage*
- > *Retrofitting existing systems is easy*



TRANSPONDER MODULE
on double Technoport as personnel exit



SINGLE SYSTEM, DOUBLE-GATE WITH ENTRY SECTION
With transponder for free passage



DOUBLE SYSTEM, DOUBLE-GATE, WITH CENTRAL DIVIDER
Left system with transponder for free passage



3 SINGLE SYSTEMS, DOUBLE-GATE
Right system with transponder for free passage

01.04 Transponder module for eGate or Technoport

■ Using **transponder modules**, unobstructed passage through the entrance system is granted.

RFID Mifare version

Transponder module integrated in robust plastic housing, anthracite grey, RAL 7016. Connector is suitable for installation on Wanzl bases with 50 mm diameter. Ideal for personnel gate at the POS.

Technical specifications

- No programming required.
- Transponder frequency 13.56 MHz*.

* The system opens with all media that support 13.56MHz such as: ID card, credit cards.

Function

Transponder module in the exit section of the electronic entrance system: used to allow staff to exit, to permit individual exit in the case of goods transport, etc.

Transponder module in the entry section of the electronic entrance system: Simple way of opening the system.

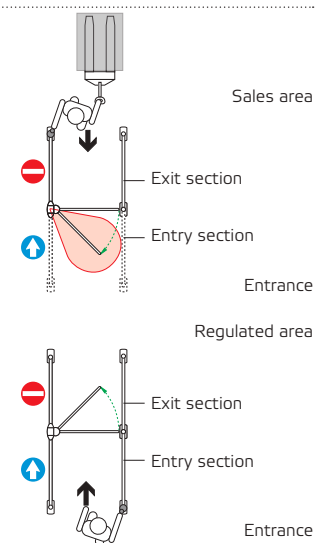

Accessories

Transponder in the form of key ring.
Connection sleeves with cable bushing for the conversion of existing systems.

Transponder module – suitable for eGate Colour, eGate, Technoport and ExitGates		
Design	RFID Mifare	
Prod.No.	98.10962.00	
Transponder module, connecting line, antenna, 1700 mm lengthways connection		
Accessories	Key ring	
Prod.No.	98.76110.00	
For activation of the modules		
Conversion kit**	eGate / eGate ExitGate	Technoport / Technoport ExitGate
R25 connection sleeve	23.83968.10	23.83968.10
R60 connection sleeve	-	23.09571.10
For implementation of the 1700 mm lengthways connection		

** In the case of systems without entry/exit sections, the corresponding entry/exit system must also be ordered.

01.05 Ecoport

The classic entrance system for reducing inventory differentials

- > *Stylish and functional*
- > *High-quality engineering takes care of all safety and security issues*
- > *Individual and double-gate versions with intermediate and exit sections*



SINGLE SYSTEM, DOUBLE-GATE
Classic swivel barrier, opening to the left



SINGLE SYSTEM, DOUBLE-GATE WITH ENTRY SECTION
Classic swivel barrier, with sign, opening to the left



DOUBLE SYSTEM, DOUBLE-GATE, WITH CENTRAL DIVIDER
Classic swivel barrier, with sign, opening to the left/right



3 SINGLE SYSTEMS, DOUBLE-GATE
Classic swivel barrier, with sign, opening to the left

01.05 Ecoport

■ **Ecoport entrance systems** from Wanzl have all the functions that you require in day-to-day use. Reliable operation, durable engineering, barrier-free access for all customers and anti-panic features as standard are a matter of course.

Design

Upright and Classic swivel barrier made of steel tubing, high-gloss chrome-plated. Pivot mechanism fully integrated in the upright – provides a particularly high level of injury protection. Sign made of white plastic or transparent acrylic glass, printed on both sides.

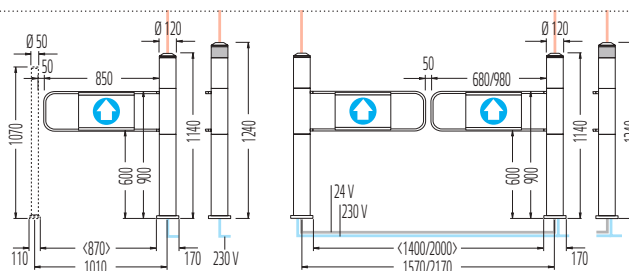

Function

Ecoport entrance systems are available with either light barriers or radar control. In the case of double-gate systems, the second system is controlled by an infrared light barrier. The radar control saves space, as in most cases it is possible to dispense with an entry section ❶.

Adjustable radar beam

Flexible adaptation of the radar beam for optimum customer registration and to suit the space available from 0.5 up to a maximum of 2.5 m.

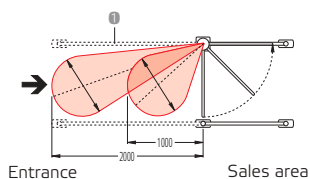

Standard technical equipment

- Max. operating voltage of 24 V DC for the highest levels of safety.
- Ecoport systems comply with both national and international safety requirements.
- Synchronised opening of the swivel barrier in all double systems without a central divider.
- Adjustable opening time from 1 to 16 seconds, the system then closes again automatically.
- Direction of opening can be adjusted on-site.

Anti-panic features

- In an emergency, the barrier can be opened in the direction of the exit.

Light barrier control - System examples

Single systems

Control with light barrier in the base of the entry section.

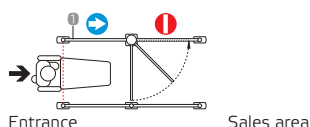

Double systems

Both uprights controlled with light barrier in the base of the entry section.

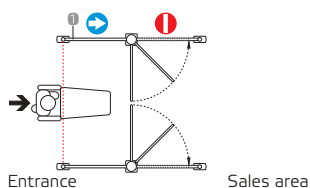

Double-gate systems

Control with light barriers in the base of the entry section and in the 1st upright.

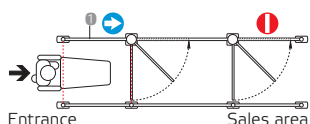

Radar control - System examples

Single systems

Radar control

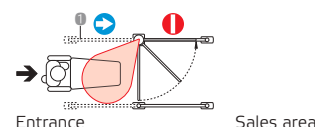

Double systems

Radar control of both uprights

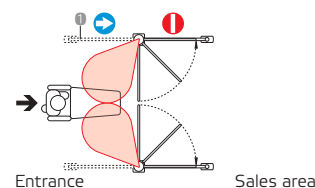

Double-gate systems

Radar control of the first upright and control of the second upright by means of a light barrier in the first upright.

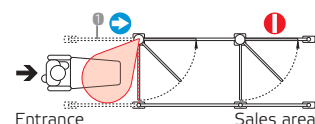

01.05 Ecoport – systems with light barrier control

Ecoport single systems	Opening to the left	Opening to the right
Prod.No.	23.08873.10-V001	23.08873.10-V002
Ecoport upright Without swivel barrier* Restriction base Exit section		
Ecoport single systems	Opening to the left, double-gate	Opening to the right, double-gate
Prod.No.	23.08874.10-V001	23.08874.10-V002
2 Ecoport uprights Without swivel barrier* 2 restriction bases Intermediate section Exit section		
Ecoport double system	Opening in both directions	
Prod.No.	23.08879.10-V001	
2 Ecoport uprights Without swivel barrier* Exit section		
Ecoport double system	Opening to the left or right, with central divider	
Prod.No.	23.08885.10-V001	
2 Ecoport uprights Without swivel barrier* Exit section Central divider		
Ecoport double system	Opening in both directions, double-gate	
Prod.No.	23.08880.10-V001	
4 Ecoport uprights Without swivel barrier* Intermediate section Exit section		
Ecoport double system	Opening to the left or right with central divider, double-gate	
Prod.No.	23.08886.10-V001	
4 Ecoport uprights Without swivel barrier* Intermediate section Exit section Central divider		

Classic swivel barrier**	
	Prod.No.
Length	Without sign
680 mm	00.71121.10
850 mm	00.20373.10
980 mm	00.12089.10

Safe swivel barrier		
	Prod.No.	Prod.No.
Length	Opening to the left	Opening to the right
	Back of sign	
680 mm	23.73394.07-9005	23.73393.07-9005
850 mm	23.73375.07-9005	23.73374.07-9005
980 mm	23.97193.07-9005	23.97192.07-9005

* Swivel barriers, see right. ** Info signs, see the following pages

01.05 Ecoport – systems with radar control

Ecoport single systems	Opening to the left	Opening to the right
Prod.No.	23.08875.10-V001	23.08875.10-V002
Ecoport upright Without swivel barrier* Restriction base Exit section		
Ecoport single systems	Opening to the left, double-gate	Opening to the right, double-gate
Prod.No.	23.08876.10-V001	23.08876.10-V002
2 Ecoport uprights Without swivel barrier* 2 restriction bases Intermediate section Exit section		
Ecoport double system	Opening in both directions	
Prod.No.	23.08881.10-V001	
2 Ecoport uprights Without swivel barrier* Exit section		
Ecoport double system	Opening to the left or right, with central divider	
Prod.No.	23.08887.10-V001	
2 Ecoport uprights Without swivel barrier* Exit section Central divider		
Ecoport double system	Opening in both directions, double-gate	
Prod.No.	23.08882.10-V001	
4 Ecoport uprights Without swivel barrier* Intermediate section Exit section		
Ecoport double system	Opening to the left or right with central divider, double-gate	
Prod.No.	23.08888.10-V001	
4 Ecoport uprights Without swivel barrier* Intermediate section Exit section Central divider		

Classic swivel barrier**	
Prod.No.	
Length	Without sign
680 mm	00.71121.10
850 mm	00.20373.10
980 mm	00.12089.10

Safe swivel barrier		
Prod.No.		Prod.No.
Length	Opening to the left	Opening to the right
Back of sign		
680 mm	23.73394.07-9005	23.73393.07-9005
850 mm	23.73375.07-9005	23.73374.07-9005
980 mm	23.97193.07-9005	23.97192.07-9005

* Swivel barriers, see right. ** Info signs, see the following page

01.05 Ecoport – optional equipment

Power supply from the ceiling

Single system Prod.No. 23.27237.10/73/09-0000*

Double system Prod.No. 23.22831.10/73/09-0000*

230 V feed line and signal line from the ceiling mean that no structural work is necessary and simplify alterations.

Connecting cables for cross connections on single systems

4 m Prod.No. 98.72913.00 22 m Prod.No. 98.73210.00
10 m Prod.No. 98.72910.00 28 m Prod.No. 98.73466.00
16 m Prod.No. 98.73209.00

Connecting cables for cross connections on double systems
10 m Standard supply



Button

Prod.No. 98.72774.00*

The swivel barrier opens after activating the push button.



Standard control panel

Prod.No. 98.72773.00*

For manual control of systems with single opening and permanently open options.



Info signs

Prod.No. Front Back

Plastic sign, printed, for installation in the swivel barrier. Comes complete with mounting material or pre-installed.



Sign, transparent plastic

23.53553.07-0000

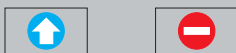

23.39918.07-0000

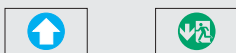

Sign, white plastic

23.46079.07-0000

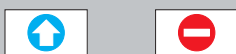

23.39925.07-0000



Digital counter

Prod.No. 23.72118.10

Counts customers using direction-sensing radar, output via digital display. Factory-set radar sensitivity enables the highest possible count accuracy.



Digital counter unit for base with 50 mm diameter

Prod.No. 98.72807.00

Recording of customer frequency. 8-digit display with reset button for resetting. Installation in the base of the entry section.



Foot-operated switch

Prod.No. 98.72775.00*

The swivel barrier opens after activating the foot-operated switch.



Special control panel

Prod.No. 98.72776.00*

Switching of systems from automatic mode to manual mode, and vice versa. For manual control of single opening and permanently open options.



Panic alarm system

Prod.No. 98.72821.00

The Wanzl anti-theft system signals opening of the swivel barrier with corresponding pressure (unauthorised or in the event of an emergency) in the exit direction with a loud klaxon noise. The acoustic warning ceases after the barrier has been pivoted back into place. In two-gate systems it is installed in the rear Ecoport upright.

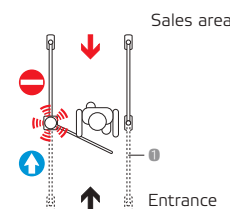

● Entry section on request

* Opening sensor, for installation at checkouts, in monitoring rooms, etc. With 5 m signal line as standard. Special lengths on request.

* See page 26 for example order.

01.06 Entrance box

For when you want to be absolutely secure

- > *Crossing light barriers*
- > *Direction-sensing radar*
- > *Electronic entrance system*

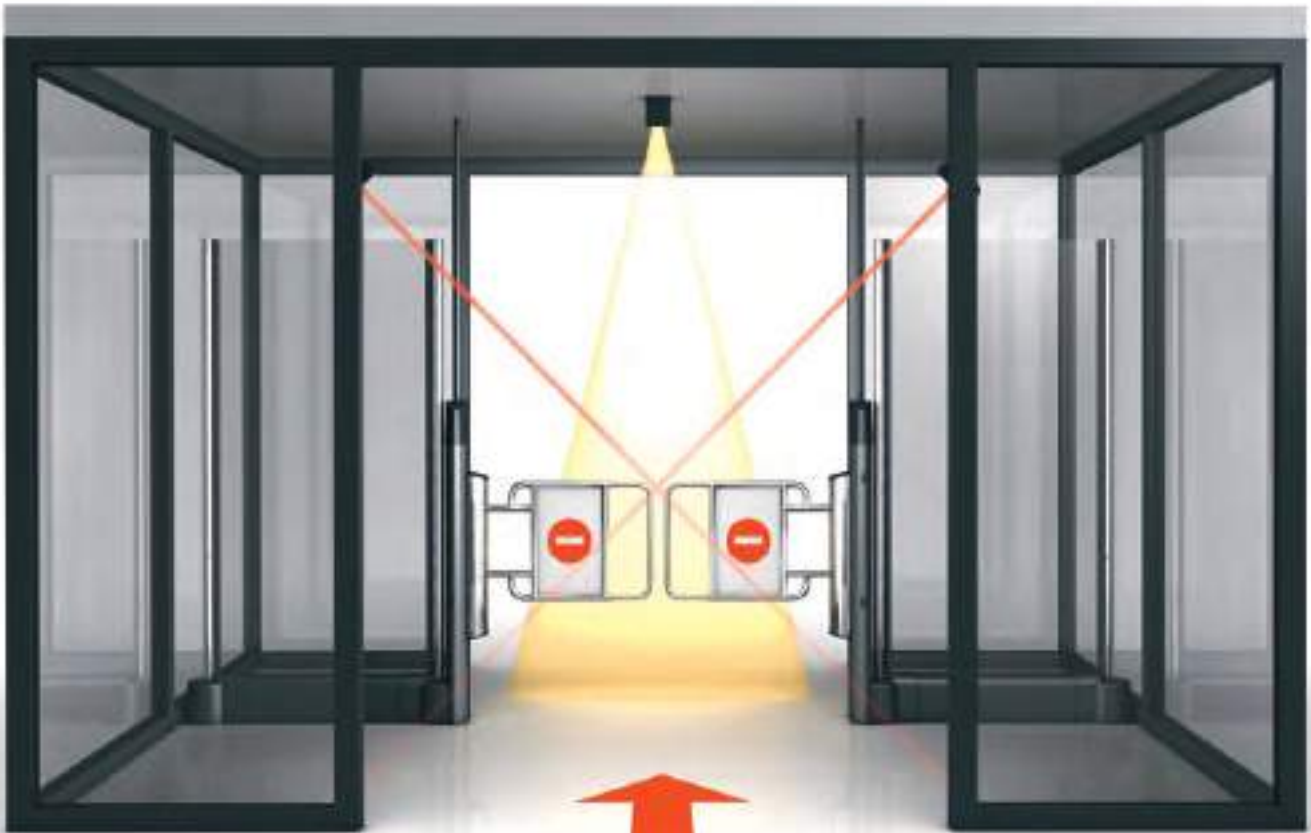

ENTRANCE BOX

View in the direction of the exit – blocked direction. With the eGate entrance system with high swivel barriers, the Railix Design partition system, direction-sensing radar and crossing light barriers



ENTRANCE BOX

View in the direction of the exit – blocked direction. With the Technoport entrance system with high swivel barriers, the Railix Security partition system, direction-sensing radar and crossing light barriers

01.06 Entrance box

■ With **Wanzl eGate or Technoport entrance systems** that are intelligently **integrated in the entrance box**, you can reduce inventory differentials safely and reliably.

Design

With Technoport or eGate single or double entrance system. Control with built-in radar, ceiling radar and crossing light barrier.

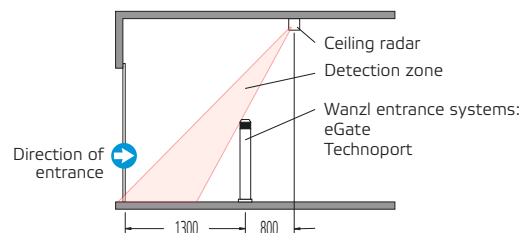

Function

Customers enter the store through the door box with automatic doors and an entrance system. The two-stage registration of people who wish to leave the store by the entrance ensures a high level of protection against inventory differentials.

Adjustable radar detection (radar in the upright)

Flexible adaptation of the radar beam for optimum customer registration and to suit the space available from 0.5 up to a maximum of 2.5 m.

Adjustable ceiling radar

Flexible adaptation of the radar beam for optimum customer registration and to suit the space available from 0.5 up to a maximum of 3 m.

Standard technical equipment

- Max. operating voltage of 24 V DC for the highest levels of safety.
- Systems comply with both national and international safety requirements.
- Even opening of swivel barriers. No swing back. Best positioning globally.
- Synchronised opening of the swivel barrier in all double systems without a central divider.
- Infinitely variable opening angle from 0° - 180°. Precise adjustment using the teach-in procedure.
- Freely programmable opening time, the system then closes again automatically.
- Direction of opening can be adjusted on-site.

Anti-panic features

- In an emergency, the barrier can be opened in both directions by applying counter pressure. An acoustic alarm indicates that the barrier has been opened and protects against misuse.
- The automatic barrier reset ensures that the system is ready for operation once again.

Swivel barrier for eGate and Technoport



Classic

Promotion

Swivel arm for eGate



High barrier

ES glass

For a detailed description of the eGate and Technoport electronic entrance systems, see 01 Entrance systems.

* Colours and stainless steel design on request.

01.06 Entrance box

Entrance box - system examples				
	Normal function	Exit alarm		Practical example
	Entrance	Phase 1	Phase 2	Individual
Single system with ceiling radar and exit alarm with radar in the upright				
Single system with radar modules for entrance and exit alarm in the upright				
Double unit with ceiling radar and exit alarm with radar in the uprights				
Double system with radar modules for entrance and exit alarm in the uprights				
Single system with direction-sensing light barriers for entrance and exit alarm in the upright				
Function (short version)				
Lateral entrances and exits on the entrance boxes are also possible. Moreover, installations in interior areas also form attractive access solutions, e.g. using the Wanzl Railix partition system.	The person entering is detected. The entrance system opens automatically and the person can enter the store. The system then closes again.	A person who wishes to leave the store is detected by the crossing light barrier. The radar module of the exit alarm is activated.	The person moves forward and enters the radar area. The exit alarm is triggered: There is a voice output "Warning - no exit" and at the same time an acoustic alarm is sounded.	A person wishes to enter the store and at the same time another attempts to leave the store. Possible system processes, programmed for the individual customer: A: The system opens, giving priority to the person entering. B: The system closes or does not open, no one can pass through.
Ordering, accessories				
The entrance systems for entrance boxes are adapted to your specific situation using standard components from the Wanzl customer guidance range. To achieve this, we require precise planning documents. On this basis, we send you a detailed quote. Protectors and ram protection systems are available to protect the components. A customer frequency measurement feature with access analysis may be a useful addition to the system.				

01.07 Safety turnstiles

The classic entrance solution

- > With double anti-panic feature as standard
- > Pivots out, e.g. for pallet passage
- > Certified safety "GS"



SINGLE TURNSTILE SYSTEM
Safety turnstile with passage for shopping trolleys

ALARM SYSTEM
Acoustic, reduces shoplifting – available on request.



01.07 Safety turnstiles

■ **Wanzl safety turnstiles** are a secure and safe investment. Secure because they help to reduce inventory differentials effectively and safe because the double anti-panic feature ensures effective protection for your customers.

Design

Turnstile made of steel tubing that can be pivoted out, complete with Classic customer guidance system and bases to allow shopping trolleys to pass through*. Design offering reliable operation with double anti-panic feature. Surfaces: high-gloss chrome-plated, coloured plastic powder-coated* or stainless steel.

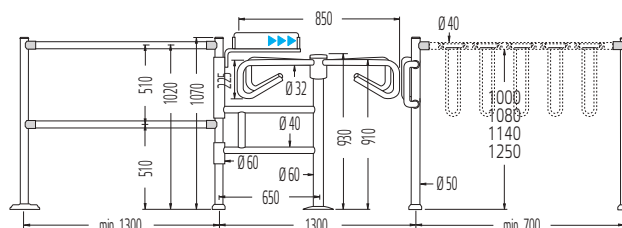

Function

The turnstile is activated manually, the direction of rotation can be switched on-site. For pallet passage, the turnstile is lifted up from the turnstile fixing and pivoted out. The castor integrated in the turnstile base prevents damage to the floor.

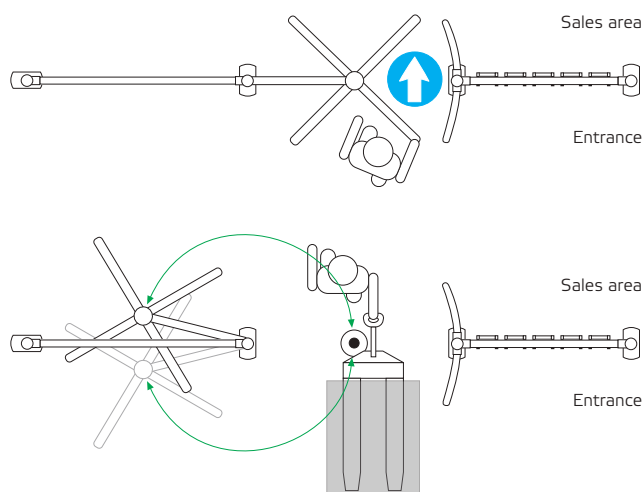
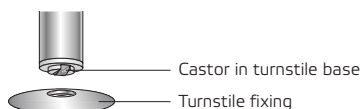

Double anti-panic feature

Anti-panic feature 1: With a certain amount of counter-pressure, the safety turnstile's direction of rotation can be reversed. This prevents injury to any persons who may be jammed in the turnstile. After rotation through 90°, the turnstile engages again.

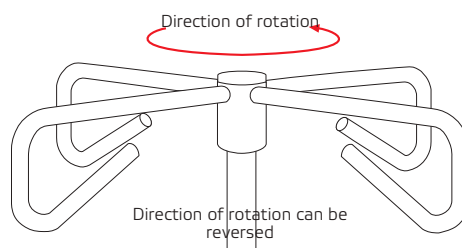

Anti-panic feature 2: With strong counter-pressure, the safety turnstile releases from the turnstile fixing without being raised and pivots in the direction of the exit. An emergency exit measuring a maximum of 1250 mm is released.

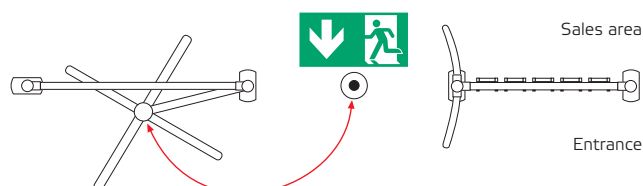

*Connecting tube and locking barrier for passage of shopping trolleys to be ordered separately, colours available on request.

01.07 Safety turnstiles

Safety turnstile system					
Swivelling turnstile	Base with semi-circle arch	Base with semi-circle arch and connection sleeve (metal)	Base with semi-circle arch and connection sleeve (metal)	Base with connection sleeve (metal)	Base with connection sleeve (metal)
23.24567.10/73/09-7019*	Height 1070 mm 23.12558.10/73/09-7019*	PC 1140 mm 23.45645.10/73/09-7019*	PC 1250 mm 23.45646.10/73/09-7019*	PC 1140 mm 23.45659.10/73/09-7019*	PC 1250 mm 23.45660.10/73/09-7019*
Please order base separately. See page 69		PC: Passage clearance dependent on type of shopping trolley Connection sleeve with anti-swivel locking mechanism for connecting tubes	PC: Passage clearance dependent on type of shopping trolley Connection sleeve with anti-swivel locking mechanism for connecting tubes	PC: Passage clearance dependent on type of shopping trolley Connection sleeve with anti-swivel locking mechanism for connecting tubes	PC: Passage clearance dependent on type of shopping trolley Connection sleeve with anti-swivel locking mechanism for connecting tubes

Mounted barrier		
Type	Barrier without silencer	Barrier with silencer
Prod.No. per item	23.05265.07	23.38851.07
Made of shatter-proof plastic, pure orange RAL2004, light grey RAL7035, traffic green RAL 6024 or fire red RAL 3000. Polyurethane foam silencer.		
	1000 or 1500 mm connecting tubes see page 69	1000 or 1500 mm connecting tubes see page 69

4 - 5 units recommended for every 1000 mm

Info signs	Opening to the left/right	Opening to the left	Opening to the right
Printing on the front/back	▶▶▶ / ◻	▶▶▶ / ◻	◻◻◻ / ◻
Prod.No.	23.04021.10	23.45655.10	23.86898.10
Suitable for single turnstile systems. Plastic sign, printed on both sides, with pivoting safety barrier			

Info signs	Opening to the left/right	Opening to the left	Opening to the right
Printing on the front/back	▶▶▶ / ◻	▶▶▶ / ◻	◻◻◻ / ◻
Prod.No.	23.18213.10	23.45656.10	23.87124.10
Suitable for double turnstile systems. Plastic sign, printed on both sides. Safety barrier can be pivoted out if necessary.			

Sign for passage of shopping trolleys
 Prod.No. 23.20481.10
 Sign measuring 670 x 200 x 4 mm, plastic, printed on both sides. With mount.

◻
Back of sign

Rotatable protective wheel
 Prod.No. 23.04244.10-7035/2004

Plastic, RAL7035 or RAL2004. Outer diameter 180 mm. Delivery with adjusting rings for installation at the height of the shopping trolley type in use.

* See page 26 for example order

01.08 Swing gates

Simply compact

- > *Customer-friendly solutions for many areas*
- > *Can be used at an entrance or an exit*
- > *Mechanical design*



TWO SWING GATES, MECHANICAL
as a double system



01.08 Swing gates

■ **Wanzl swing gates** are characterised by a high level of workmanship, sophisticated and reliable engineering and the fact that they require minimal maintenance in longterm use.

Design

Base, swivel tube and steel tube swivel barrier. Finishes: high-gloss chrome-plated or coloured plastic powder coating*. Integrated, hydraulically-cushioned locking device to ensure that the barrier pivots back into position evenly. Anti-panic feature as standard. Info sign made of plastic,

white, printed on both sides in the case of mechanical swing gates.

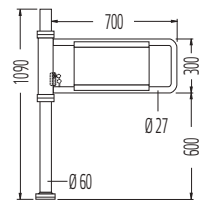

Gate closer

The closing speed is infinitely variable by hand.



Protection

Deflectors and deflector profiles are available to protect the swing gates when shopping trolleys or pallets are pushed through them.



Mechanical

- **With** anti-panic feature
- Sign printed on both sides

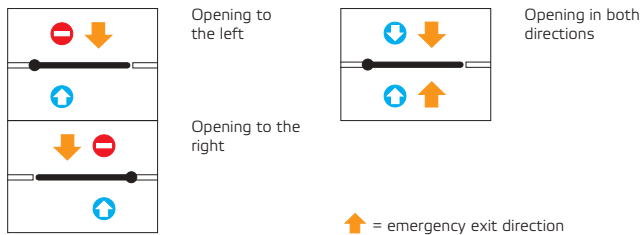

Mechanical, lockable

- **Without** anti-panic feature
- Sign with no printing

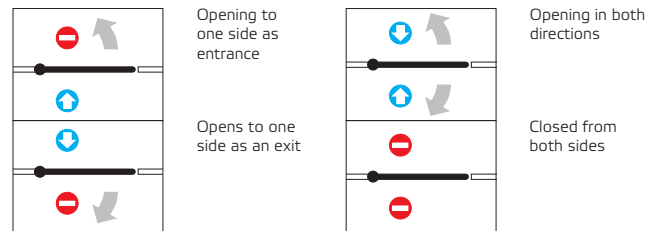

Locks, integrated in sturdy plastic housings

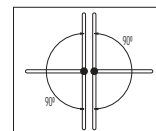

Lockable in the 90° grid

* Colours and stainless steel design on request.

01.08 Swing gates

Mechanical swing gate	Opening to the left	Opening to the right	Opening in both directions
Direction of opening			
Standard version ①	23.08723.10-V001	23.08723.10-V004	23.08723.10-V007
With deflector roll ②	23.08723.10-V002	23.08723.10-V005	23.08723.10-V008
With deflector roll and deflector profile ③	23.08723.10-V003	23.08723.10-V006	23.08723.10-V009
Swing door with swivel barrier and sign printed on both sides			

Swivel barriers: ① , ② , ③ , ④ , ⑤ , ⑥

Spare parts and accessories:

Info signs	↑ / -	- / -	↑ / ↓	without / without
Printing on the front/back				
400 x 237 mm Prod.No.	00.12746.07	00.12714.07	00.39979.07	00.49655.07
500 x 237 mm Prod.No.	00.12599.07	00.43348.07	00.41352.07	00.49656.07
400 x 237 mm signs suitable for swing gates in standard version				
500 x 237 mm signs suitable for swing gates with deflector roll				
Plastic profile for installation of the info sign	Deflector profile for swing gates with deflector roll			
Length 400 mm Prod.No.	00.12713.07	Prod.No.		00.41357.07
Length 500 mm Prod.No.	00.12600.07	1 piece, incl. fixing material		

02 Product overview

02.01 Railix Colour partition system



02.02 Railix Design partition system



02.03 Railix Security partition system



02.04 Railix Basic partition system



02.05 Classic partition system



02.06 Classic customer guidance system



02 Guidance systems



02.01 Railix® Colour partition system

Partitions with the right perspective

- > *An attractive feature in an entrance area*
- > *Effective division of spaces*
- > *Energy-saving LED technology in freely programmable colours*



RAILIX COLOUR

Closed front, with no possibility of reaching through

02.01 Railix® Colour partition system

■ **The Wanzl Railix Colour** partition system creates atmosphere in the entrance area and integrates perfectly into a high-value retail setting. This means guaranteed appearance, and an opportunity to use your CI if desired.

Dramatic

Acrylic glass elements direct the coloured light and create openness and transparency.

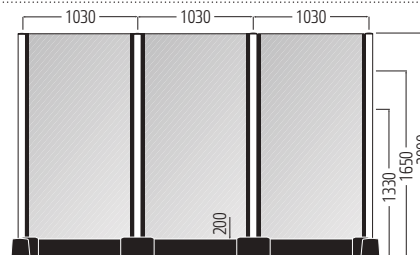

LED inside

The colours and the different colour gradients can be individually selected with a hand-held transmitter.



Bases, partition elements

Design: Bases made of steel tubes with base plate. Plastic insert profiles, plinth and corner elements, plinth profiles and wall mounts in anthracite grey, RAL 7016. Acrylic glass partition elements.

Finish: Bases with high-gloss chrome plating, plastic powder coating, or stainless steel.

Dimensions:

Base diameter	50 mm
Base height	1330 mm
	1650 mm
	2000 mm
Acrylic glass partition elements	950 x 1150 mm
	950 x 1470 mm
	950 x 1820 mm

Inventory differentials

Perfect protection against shoplifting. Completely closed with no gaps, up to a height of 2 m.



Protection

Plinth and corner elements, as well as plinth profiles, provide perfect protection against damage caused by shopping trolleys.



LED technology: Energy-saving, long-lasting LED light units. The colours and the different colour gradients can be individually selected by hand-held transmitter.

Hand-held transmitter: A hand-held transmitter is required for each installation. Please always order separately.
LED-RGB hand-held transmitter

Prod.No. 98.74776.00-0000

Cleaning

The flush floor connection makes the partitioned area particularly easy to clean – no matter whether cleaning is carried out by hand or using a machine.



*Connecting tube and locking barrier for passage of shopping trolleys to be ordered separately, colours available on request.

02.01 Railix® Colour partition system



Railix Colour						
Bases						
	Start/end base	Start/end base for eGate Colour	Centre base 180°	Corner base 90°	T joint base 2 x 90°	
Consists of: - Base with base plate - U-shaped insert profile(s) Finishes* - .10 High-gloss chrome-plated - .73 Plastic powder-coated (colours available on request) - .09 Stainless steel						
Height	Prod.No.	Prod.No.	Prod.No.	Prod.No.	Prod.No.	
1330 mm	23.42520.10/73/09-7016	23.56983.10/73/09-7016	23.42521.10/73/09-7016	23.42522.10/73/09-7016	23.42525.10/73/09-7016	
1650 mm	23.42530.10/73/09-7016	23.56984.10/73/09-7016	23.42531.10/73/09-7016	23.42532.10/73/09-7016	23.42535.10/73/09-7016	
2000 mm	23.42540.10/73/09-7016	23.56985.10/73/09-7016	23.42541.10/73/09-7016	23.42542.10/73/09-7016	23.42545.10/73/09-7016	
Plinth and corner elements						
Plastic, anthracite grey, RAL 7016						
Inner diameter	Prod.No.	Prod.No.	Prod.No.	Prod.No.	Prod.No.	
For bases with 50 mm diameter	23.47810.07-7016	23.57209.07-7016	23.51765.07-7016	23.48940.07-7016	23.51200.07-7016	







Standard colours for insert profile, plinth and corner elements, plinth profiles and wall mountings  anthracite grey RAL7016

02.01 Railix® Colour partition system



RAILIX COLOUR
Various angled connections
Height 1650 mm

RAILIX COLOUR
Housing
Height 2000 mm

Base		U-shaped insert profile for wall mounting		Railix Colour Partition elements	
Double connection	Variable angles				Partition element Acrylic glass
				Consists of: - Acrylic glass element, 6 mm sheet thickness	
Prod.No.	Prod.No.	Width x Height	Prod.No.		
23.42523.10/73/09-7016	23.42526.95-7016	950 x 1150 mm	23.36530.07-9095		
23.42533.10/73/09-7016	23.42536.95-7016	950 x 1470 mm	23.36531.07-9095		
23.42543.10/73/09-7016	23.42546.95-7016	950 x 1820 mm	23.36532.07-9095		
Plinth profiles		Master element**		Slave element	
	Length 2000 mm, adjustment on-site. See page 155 for fixing material	With insertion groove for partition elements, made from plastic, anthracite grey RAL 7016	 With electronics		
Prod.No.		Width	Prod.No.	Prod.No.	
23.47697.07-7016		For bay width 1000 mm	23.36304.95-7016	23.36305.95-7016	

* Example orders:
23.42520.10-7016 High-gloss chrome-plated
23.42520.73-7016 Plastic powder coating, please specify the colour required.
23.42520.09-7016 Stainless steel

** Requirements:
1 piece for 2 elements measuring 2000 mm in height
1 piece for 3 elements measuring 1650 mm in height
1 piece for 4 elements measuring 1330 mm in height

02.02 Railix® Design partition system

Transparent partitioning

- › Variable and cost-effective way of designing spaces
- › High level of protection against damage
- › Effective protection against shoplifting



RAILIX DESIGN

Closed front, with high level of protection against theft

02.02 Railix® Design partition system

■ The **Wanzl Railix Design partition system** makes perfect room partitions possible. It is flexible and adaptable in all directions – thanks to corner elements that permit connections at between 90° and 270°. An elegant, easy to install and therefore cost-saving room solution offering a great deal of creative freedom.

With transparency

Transparent acrylic glass elements and/or wire grate elements effectively separate the different areas.

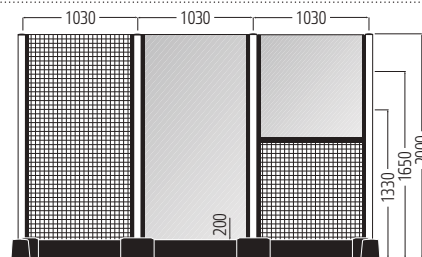

Inventory differentials

The acrylic glass elements close fully with no gaps, while the wire grates have a mesh size of 50 x 50 mm.



Bases, partition elements

Design: Bases made of steel tubes with base plate. Plastic insert profiles, plinth and corner elements, plinth profiles and wall mounts in anthracite grey, RAL 7016. Partition elements made of wire grate: high-gloss chrome-plated, plastic powder-coated or in transparent acrylic glass.

Protection

Plinth and corner elements, as well as plinth profiles, provide perfect protection against damage caused by shopping trolleys.



Finish: Bases with high-gloss chrome plating, plastic powder coating, or stainless steel. Wire grate elements: high-gloss chrome-plated or plastic powder-coated.

Dimensions:

Base diameter	50 mm
Base heights	1330 mm
	1650 mm
	2000 mm
Acrylic glass partition elements	960 x 1150 mm
	960 x 1470 mm
	960 x 1820 mm
Wire grate partition element	960 x 1820 mm
Acrylic glass/wire grate partition element	960 x 1820 mm

Cleaning

The flush floor connection makes the partitioned area particularly easy to clean – no matter whether cleaning is carried out by hand or using a machine.



*Connecting tube and locking barrier for passage of shopping trolleys to be ordered separately, colours available on request.

02.02 Railix® Design partition system



RAILIX DESIGN
Housing
Height 2000 mm



RAILIX DESIGN
Various angled connections
Height 1330 mm

Railix Design						
Bases						
	Start/end base	Start/end base for eGate®	Centre base 180°	Corner base 90°	T joint base 2 x 90°	Base Double connection Variable angles
Consists of: - Base with base plate - U-shaped insert profile(s) Finishes* - .10 High-gloss chrome-plated - .73 Plastic powder-coated (colours available on request) - .09 Stainless steel						
Height	Prod.No.	Prod.No.	Prod.No.	Prod.No.	Prod.No.	Prod.No.
1330 mm	23.12117.10/73/09-7016	23.39242.10/73/09-7016	23.08614.10/73/09-7016	23.08167.10/73/09-7016	23.53598.10/73/09-7016	23.08054.10/73/09-7016
1650 mm	23.36191.10/73/09-7016	23.36198.10/73/09-7016	23.36192.10/73/09-7016	23.36193.10/73/09-7016	23.36195.10/73/09-7016	23.36194.10/73/09-7016
2000 mm	23.46341.10/73/09-7016	23.35970.10/73/09-7016	23.46567.10/73/09-7016	23.46906.10/73/09-7016	23.51313.10/73/09-7016	23.47471.10/73/09-7016
Plinth and corner elements						
Plastic, anthracite grey, RAL 7016						
Inner diameter	Prod.No.	Prod.No.	Prod.No.	Prod.No.	Prod.No.	Prod.No.
For bases with 50 mm diameter	23.47810.07-7016	23.57209.07-7016	23.51765.07-7016	23.48940.07-7016	23.51200.07-7016	23.47697.07-7016

Standard colours for insert profile, plinth and corner elements, plinth profiles and wall mountings  anthracite grey RAL 7016

02.02 Railix® Design partition system



RAILIX DESIGN
Various angled connections
Height 2000 mm

RAILIX DESIGN
Wall attachment
Height 1650 mm

Base Triple connection Variable angles	U-shaped insert profile for wall mounting
Prod.No. 23.73260.10/73/09-7016 23.36197.10/73/09-7016 23.53686.10/73/09-7016	Prod.No. 23.54364.95-7016** 23.54364.95-7016** 23.54364.95-7016**
Prod.No. 23.53912.07-7016	

Railix Design			
Partition elements			
	Wire grate	Acrylic glass	Wire grate/ Acrylic glass
Consists of: - Wire grate, wire with 5 mm diameter, mesh size 50 x 50 mm - Acrylic glass, transparent 9095, sheet thickness 6 mm or - Combination of wire grate and acrylic glass, as above			
Width x Height	Prod.No.	Prod.No.	Prod.No.
960 x 1150 mm	-	23.09066.07-9095	-
960 x 1470 mm	-	23.73486.07-9095	-
960 x 1820 mm	23.47584.10-0000	23.41934.07-9095	23.48375.95-7016
Plinth profiles			
With insertion groove for partition elements, made from plastic, anthracite grey RAL 7016			
Width	Prod.No.	Prod.No.	Prod.No.
For bay width 1000 mm	23.48262.95-7016	23.48262.95-7016	23.48262.95-7016



H-shaped insert profile
Length 930 mm
Prod.No. 23.14814.07-7016
Plastic, RAL7016 anthracite grey

* Example orders:
23.42520.10-7016
High-gloss chrome-plated
23.42520.73-7016
Plastic powder coating, please specify the colour required.
23.42520.09-7016
Stainless steel

** Length 2000 mm, adjustment on-site. See page 155 for fixing material.

02.03 Railix® Security partition system

Room partition to satisfy the very highest requirements

- > *Transparent room partition for every security requirement*
- > *High resistance level*
- > *Fast and economical assembly*



RAILIX SECURITY
With particularly hard-wearing base profile



02.03 Railix® Security partition system

■ **Wanzl Railix Security partition system.** The rectangular base profile forms the foundation for this sophisticated, high-quality and proven partition system, thus enabling quick and easy installation.

Clear

Transparent acrylic glass elements effectively separate the different areas.

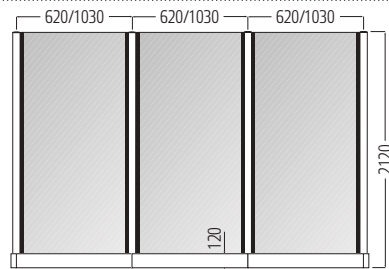

Inventory differentials

The acrylic glass elements close fully with no gaps, effectively making shoplifting more difficult.



Bases, partition elements

Design: Bases made of steel tubes with base plate. Insert profiles made of plastic in RAL 7047, tele grey 4. Rectangular base profile made of high-gloss chrome-plated steel. Partition elements made of acrylic glass, transparent, 9095.

Finish: Bases with high-gloss chrome plating.

Dimensions:

Base diameter	50 mm
Base heights	2120 mm
Acrylic glass partition elements	550 x 2000 mm 960 x 2000 mm

Sturdy protection

The rectangular base profile provides protection and is resistant to high levels of stress.



Cleaning

The flush floor connection makes the partitioned area particularly easy to clean – no matter whether cleaning is carried out by hand or using a machine.







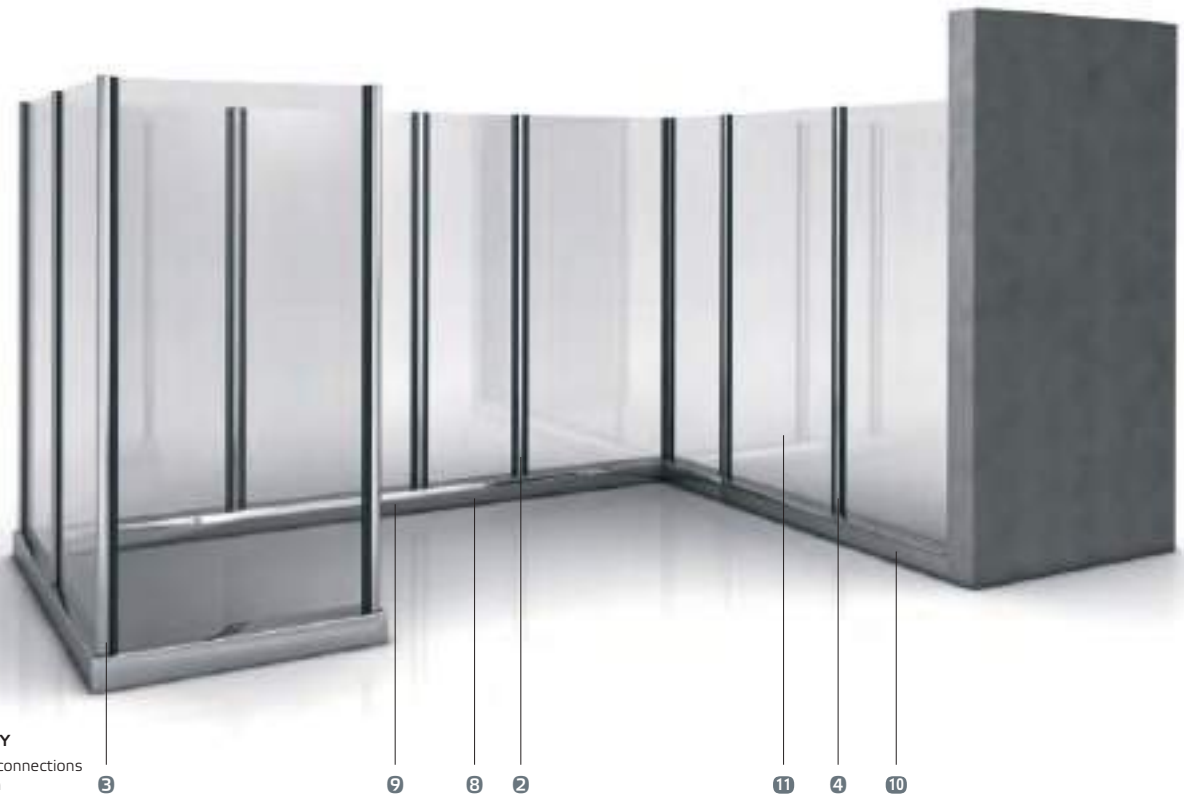









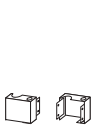
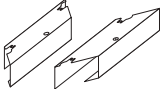
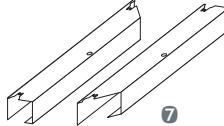

*Connecting tube and locking barrier for passage of shopping trolleys to be ordered separately, colours available on request.

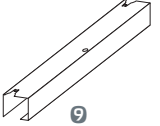
02.03 Railix® Security partition system



RAILIX SECURITY
 Angled and wall connections
 Height 2120 mm

Railix Security					
Bases					
	Start/end base Left	Centre base 180°	Corner base 90°	T joint base 2 x 90°	
Consists of: - Base with base plate - U-shaped insert profile(s) Finishes - .10 High-gloss chrome-plated					
	 1	 2	 3	 4	
Height 2120 mm	Prod.No. 23.91763.10-7047	Prod.No. 23.91764.10-7047	Prod.No. 23.91765.10-7047	Prod.No. 23.47712.10-7047	
Security elements					
	End element Length 36 mm	Corner element Length 620 mm	Corner element Length 1030 mm	Centre element Length 620 mm	Centre element Length 1030 mm
Finishes - .10 High-gloss chrome-plated					
	 6	 7	 8	 9	 10
Design	Prod.No.	Prod.No.	Prod.No.	Prod.No.	Prod.No.
Left	23.58216.10	23.75608.10	23.91989.10	23.05096.10	23.91990.10
Right	23.57877.10	23.75834.10	23.91988.10		

02.03 Railix® Security partition system

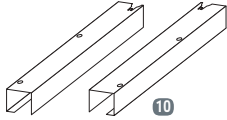
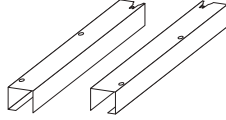

RAILIX SECURITY
Housing, e.g. for back-shops
Height 2120 mm

Start/end base Right	
	
Prod.No. 23.91762.10-7047	
Connection element Length 915 mm	Connection element Length 985 mm
	
Prod.No. 23.75157.10 23.75156.10	Prod.No. 23.64539.10 23.64426.10

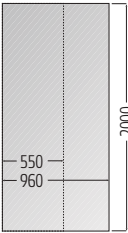
Railix Security Partition elements	
Acrylic glass element	
Consists of: - Acrylic glass, transparent, sheet thickness 6 mm	
	
Width x Height	Prod.No.
550 x 2000 x 6 mm	23.72331.07-9095
960 x 2000 x 6 mm	23.71992.07-9095

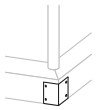
Railix Security Accessories	
Corner reinforcement	
Consists of: - Corner reinforcement - Fixing material Finish - High-gloss chrome-plated - .73 Plastic powder-coated (colours available on request) - .09 Stainless steel	
	
Prod.No.	
23.64431.10	

02.04 Railix® Basic partition system

Elegant clarity

- › *Versatile applications possible*
- › *Generous feeling of space due to unobtrusive construction*
- › *Cost-effective dividing elements for many areas of application*



Partition element in security design

RAILIX BASIC

Partition elements that do not allow anyone to reach round the side

02.04 Railix® Basic partition system

■ **Wanzl Railix Basic partition system.** With this system, room partitions and barriers gain a “face” and characterise and divide rooms into multiple areas. Its range of uses extends from effective draught prevention to attractive privacy protection.

Clear division

Transparent acrylic glass elements and/or wire grate elements effectively separate the different areas.

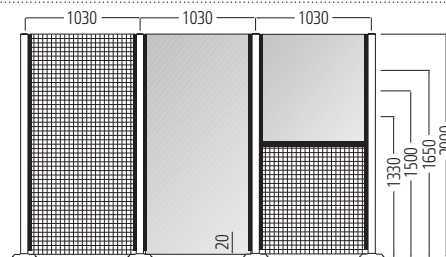

Inventory differentials

The acrylic glass elements close fully at the side, with no gaps, while the wire grates have a mesh size of 50 x 50 mm.



Bases, partition elements

Design: Bases made of steel tubes with base plate. Insert profiles made of plastic in RAL 7016, anthracite grey. Partition elements made of wire grate: high-gloss chrome-plated or plastic powder-coated or in transparent acrylic glass.

Finish: Bases with high-gloss chrome plating, plastic powder coating, or stainless steel. Wire grate elements: high-gloss chrome-plated or plastic powder-coated.

Dimensions:

Base diameter	50 mm
Base heights	1330 mm
	1500 mm
	1650 mm
	2000 mm

Stable base plates

Large base plates with metal base plate covers ensure stability of the bases.



Partition elements

Solutions tailored to the situation can be achieved with a wide range of sheet materials, e.g. wood, perforated steel plate or plastic.



Acrylic glass partition elements	960 x 1310 mm
	960 x 1480 mm
	960 x 1630 mm
	960 x 1980 mm
Wire grate partition elements	960 x 1310 mm
	960 x 1480 mm
	960 x 1630 mm
	960 x 1980 mm
Acrylic glass/wire grate partition elements	960 x 1980 mm

Security design

The partition elements with recesses for base plates close gaps at the floor securely.



*Connecting tube and locking barrier for passage of shopping trolleys to be ordered separately, colours available on request.

02.04 Railix® Basic partition system

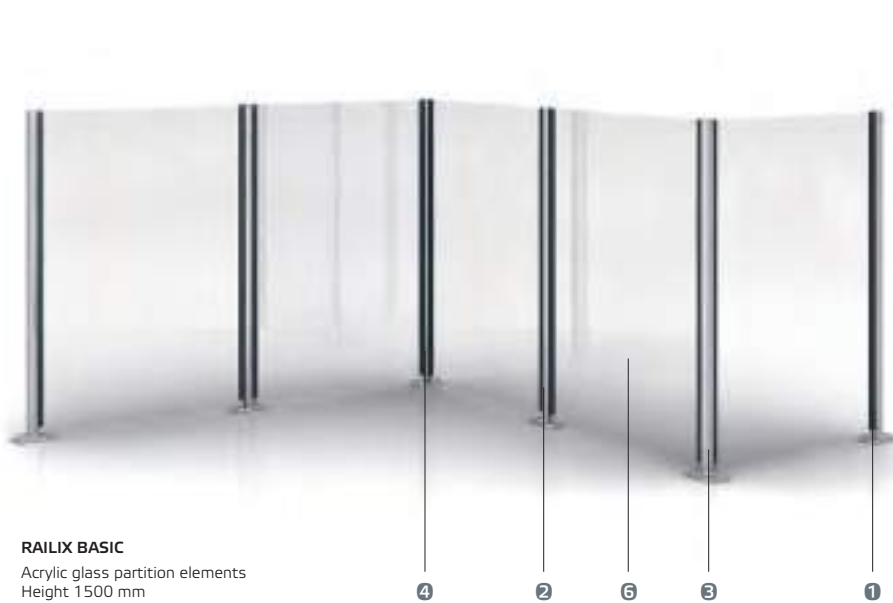

RAILIX BASIC
Acrylic glass partition elements
Height 1500 mm



RAILIX BASIC
Wire grate partition elements
Height 2000 mm

Railix Basic						
Bases						
	Start/end base	Centre base 180°	Corner base 90°, left	Corner base 90°, right	T joint base 2 x 90°	Corner base, variable corner
Consists of:	<ul style="list-style-type: none"> - Base with base plate - U-shaped insert profile(s) 					
Finishes*	<ul style="list-style-type: none"> - .10 High-gloss chrome-plated - .73 Plastic powder-coated (colours available on request) - .09 Stainless steel 					
Height	Prod.No.	Prod.No.	Prod.No.	Prod.No.	Prod.No.	Prod.No.
1330 mm	23.04432.10/73/09-7016	23.04434.10/73/09-7016	23.08274.10/73/09-7016	23.08275.10/73/09-7016	23.04435.10/73/09-7016	23.19467.10/73/09-7016
1500 mm	23.19899.10/73/09-7016	23.19902.10/73/09-7016	23.19909.10/73/09-7016	23.85664.10/73/09-7016	23.19910.10/73/09-7016	23.34486.10/73/09-7016
1650 mm	23.93262.10/73/09-7016	23.93264.10/73/09-7016	23.93266.10/73/09-7016	23.93265.10/73/09-7016	23.93267.10/73/09-7016	23.93268.10/73/09-7016
2000 mm	23.85660.10/73/09-7016	23.85661.10/73/09-7016	23.85662.10/73/09-7016	23.85663.10/73/09-7016	23.19903.10/73/09-7016	23.74842.10/73/09-7016

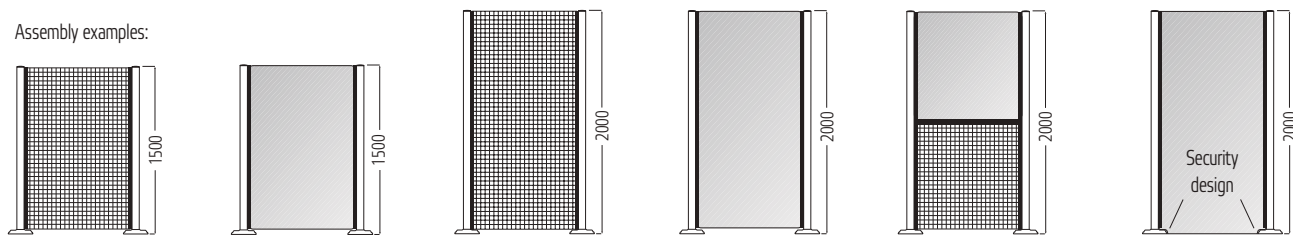

02.04 Railix® Basic partition system



RAILIX BASIC
Wire grate and acrylic glass partition elements
Height 2000 mm

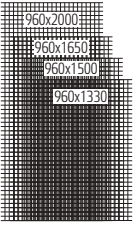
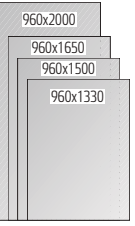
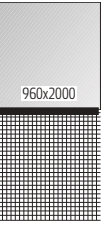

Railix Basic				
Partition elements				
	Wire grate	Acrylic glass, transparent	Wire grate/acrylic glass, transparent	
Consists of:				
			5	6
				7
Width x Height	Prod.No.	Prod.No.	Prod.No.	
Rectangular				
960 x 1310 mm	23.81942.10/73-0000	23.81941.07-9095	-	
960 x 1480 mm	23.21143.10/73-0000	23.19906.07-9095	-	
960 x 1630 mm	23.93269.10/73-0000	23.93261.07-9095	-	
960 x 1980 mm	23.21142.10/73-0000	23.19904.07-9095	23.08260.95-7016	
Security design, rectangular with recesses for base plates				
960 x 1500 mm	23.21146.10/73-0000	23.85771.07-9095	-	
960 x 2000 mm	23.21144.10/73-0000	23.85773.07-9095	23.74955.95-7016	



H-shaped insert profile for vertical connection of partition elements
Length 930 mm
Prod.No. 23.14814.07-7016
Plastic, RAL7016 anthracite grey

Standard colours for insert profile and wall mounts
Anthracite grey RAL7016

* Example orders:
23.10646.**10** High-gloss chrome-plated
23.10646.**73** Plastic powder coating, please specify the colour required.
23.10646.**09** Stainless steel

** Length 2000 mm, adjustment on-site
See page 155 for fixing material

02.05 Classic partition system

Elegant transparency

- › *Versatile applications possible*
- › *Generous feeling of space due to unobtrusive construction*
- › *Attractive fixing clamps for wire grate and acrylic glass elements*



CLASSIC PARTITION SYSTEM
With attractive metal fixing clamps

02.05 Classic partition system

■ **Wanzl Classic partition system.** High-gloss chrome-plated connecting elements highlight the quality of this tried-and-tested system. The application areas are appropriate and diverse.

Clear division

Transparent acrylic glass elements and/or wire grate elements effectively separate the different areas.

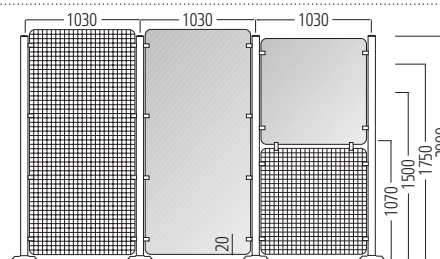

Versatile

Sturdy, high-gloss chrome-plated fixing clamps for round bases, straight walls and connectors for panels and grids.



Base - Acrylic glass

Base - Wire grate

Wall - Acrylic glass

Wall - Wire grate

Acrylic glass - Acrylic glass

Wire grate - Wire grate

Acrylic glass - Wire grate

Inventory differentials

The acrylic glass elements and wire grate with a mesh size of 50 x 50 mm are safely secured by the fixing clamps.



Bases, partition elements

Design: Bases made of steel tubes with base plates. Metal fixing clamps. Partition elements made of wire grate: high-gloss chrome-plated, plastic powder-coated or in transparent acrylic glass 9095.

Finish: Bases with high-gloss chrome plating, plastic powder coating, or stainless steel. Wire grate elements: high-gloss chrome-plated or plastic powder-coated.

Stable base plates

Large base plates with metal base plate covers ensure stability of the bases.



Dimensions:

Base diameter	50 mm
Base heights	1070/1500/1750/2000 mm
Acrylic glass partition elements	950 x 540 mm
	950 x 950 mm
	950 x 1500 mm
	950 x 2000 mm
Wire grate partition elements	960 x 540 mm
	950 x 950 mm
	950 x 1500 mm
	950 x 2000 mm

Partition elements

Appealing solutions that are appropriate for the specific situation can be achieved using wire grate and/or acrylic glass partition elements.



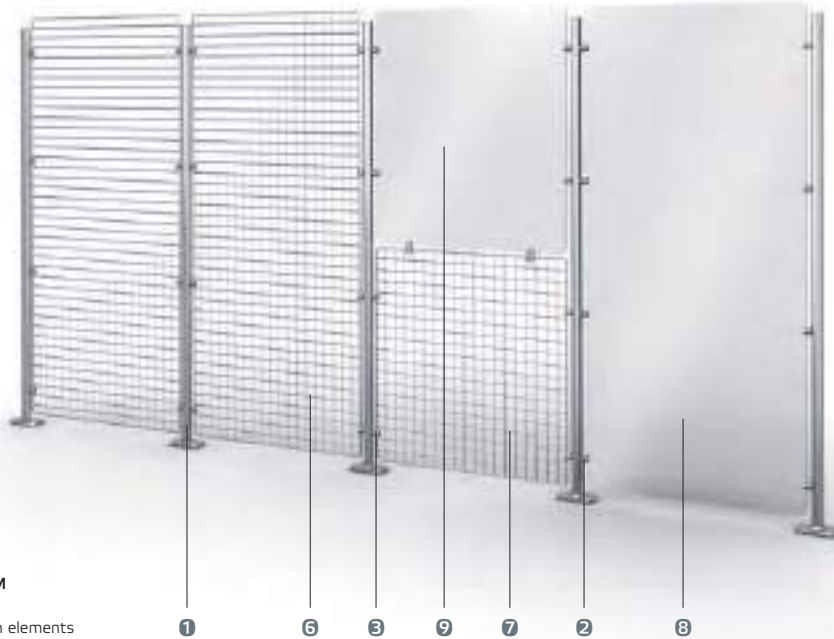

*Connecting tube and locking barrier for passage of shopping trolleys to be ordered separately, colours available on request.

02.05 Classic partition system

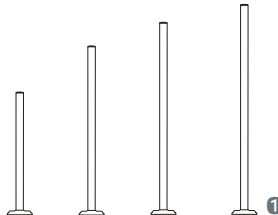
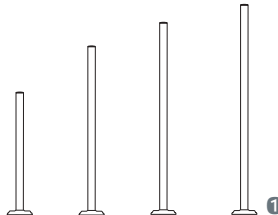

CLASSIC PARTITION SYSTEM
 Straight section
 Wire and acrylic glass partition elements
 Height of bases 2000 mm

Classic partition system	
Bases	
	Without fixing clamps Without holes
Consists of:	
- Base with base plate	
Finishes*	
- .10 High-gloss chrome-plated	
- .73 Plastic powder-coated (colours available on request)	
- .09 Stainless steel	
1	
Height	Prod.No.
1070 mm	23.10646.10/73/09
1500 mm	23.31005.10/73/09
1750 mm	23.41330.10/73/09
2000 mm	23.32761.10/73/09

Classic partition system			
Fixing clamps			
Type	For rounded bases with 50 mm diameter A/R1	A/R2	For straight back A/G1
	Attachment of panels, 6 mm thick	Attachment of wire grates, 8 mm diameter	Attachment of panels, 6 mm thick
Consists of:			
- Metal clamping elements including fixing material			
Finishes*			
- .10 High-gloss chrome-plated	2	3	4
- .73 Plastic powder-coated (colours available on request)			
Height	Prod.No.	Prod.No.	Prod.No.
Assembled	23.33050.10/73	23.33036.10/73	29.35075.10/73
Not assembled	23.32756.10/73	23.32754.10/73	29.35136.10/73



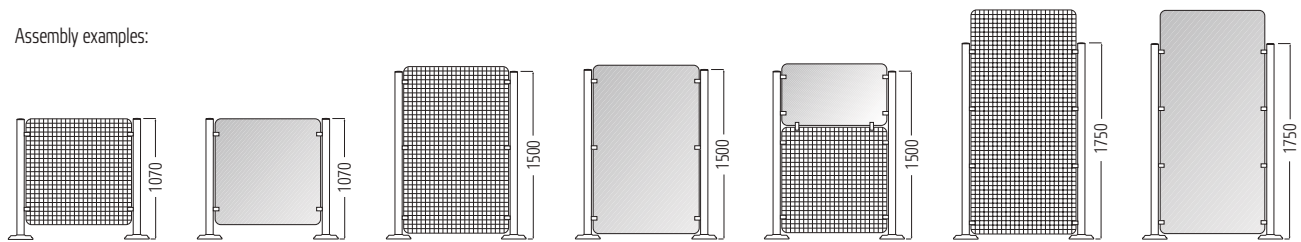

Assembly examples:

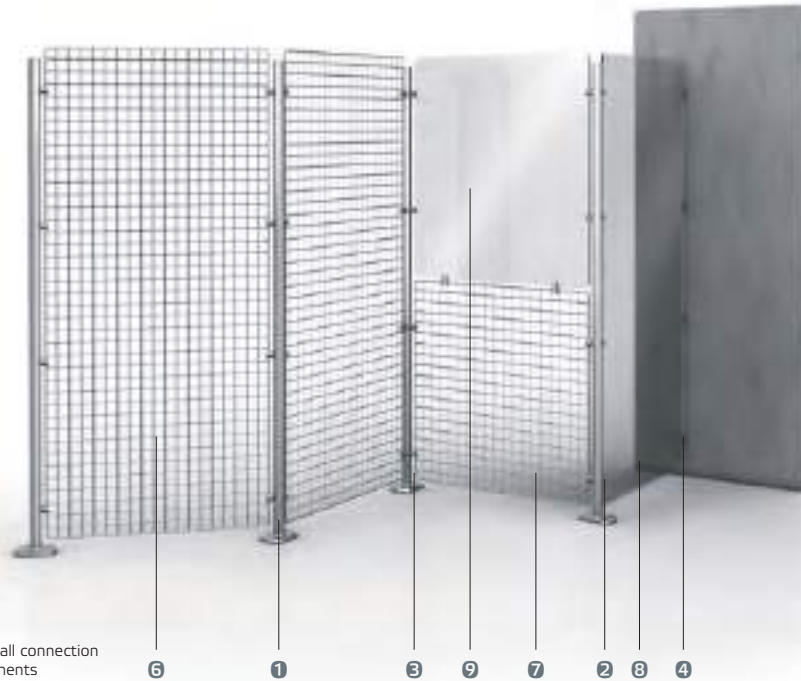

02.05 Classic partition system



CLASSIC PARTITION SYSTEM
 Section with corners, angles and wall connection
 Wire and acrylic glass partition elements
 Height of bases 2000 mm

panels A/G2	For connecting partition elements		
	B1	B2	B3
Attachment of wire grates, 8 mm diameter	Panels 6 mm thick to panels 6 mm thick	Wire grates, 8 mm diameter to wire grates 8 mm diameter	Panels 6 mm thick to wire grates, 8 mm diameter
			
Prod.No.	Prod.No.	Prod.No.	Prod.No.
29.35073.10/73	-	-	-
29.35134.10/73	23.32757.10/73	23.32758.10/73	29.51737.10/73

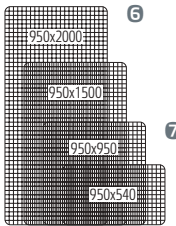
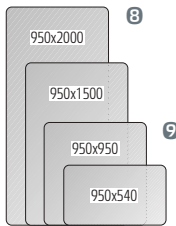
Classic partition system		
Partition elements		
	Wire grate	Acrylic glass, transparent
Consists of:		
- Wire grate, wire with 5 mm diameter, mesh size 50 x 50 mm		
- Acrylic glass, transparent 9095, sheet thickness 6 mm		
Finishes for wire grate*		
- .10 High-gloss chrome-plated		
- .73 Plastic powder-coated (colours available on request)		
		
Width x Height	Prod.No.	Prod.No.
950 x 540 mm	23.44982.10/73	23.44979.07-9095
950 x 950 mm	23.44983.10/73	23.44977.07-9095
950 x 1500 mm	23.44984.10/73	23.44978.07-9095
950 x 2000 mm	23.64672.10/73	23.58412.07-9095

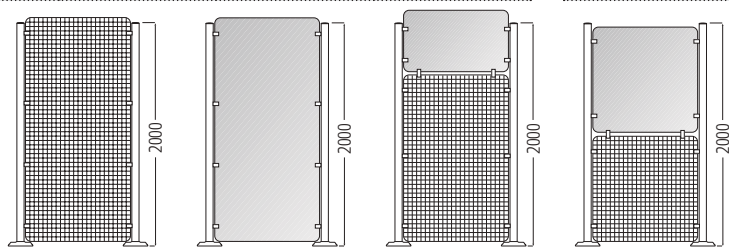

* Example orders:
 23.10646.10 High-gloss chrome-plated
 23.10646.73 Plastic powder coating, please specify the colour required.
 23.10646.09 Stainless steel

02.06 Classic customer guidance system

Practical functionality – effective spatial organisation

- > *Tried-and-tested guidance system for many areas*
- > *Fully compatible with the Wanzl customer guidance system/customer guidance components*
- > *Chrome-plated, coloured coating, or stainless steel design*

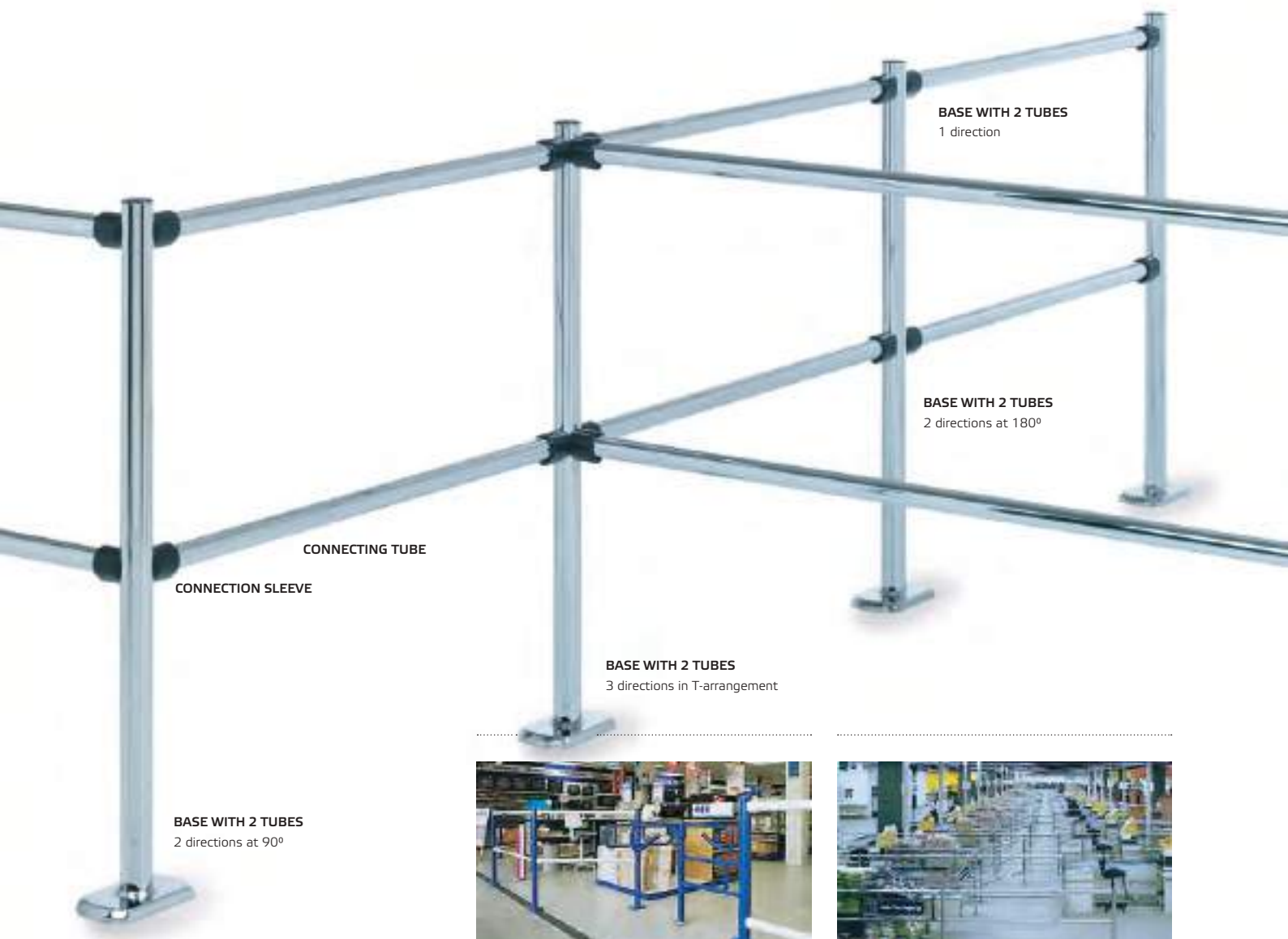

02.06 Classic customer guidance system

■ With the **Wanzl Classic customer guidance system**, you can steer the flow of customers, divide and link rooms, block and open up passages in a flexible manner – irrespective of the spatial conditions.

Three designs

Clear and friendly for every ambiance and corporate design.



Base
2 tubes

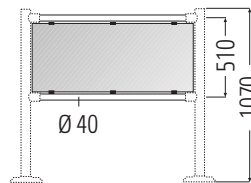

Partition element
Suitable for bases with 2 tubes

Optional

Coloured connection sleeves and end caps in nine colours. The standard colour is anthracite grey, RAL 7016.



Sleeves
1 direction

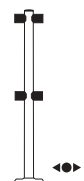

Sleeves
180°

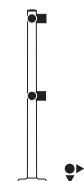

Sleeves
90°

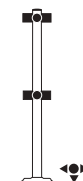

Sleeves
T-arrangement

Assembly

Assembly of bases on fitted floors.

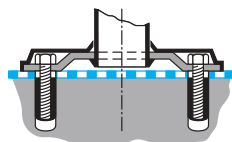

Bases, connecting tubes, partition elements

Design:

Bases made of steel tubing with base plate for double-tube connection. Metal base plate covers. Connection sleeves made from metal, high-gloss chrome-plated or plastic, anthracite grey RAL7016.

Connecting tubes and partition elements made of steel tubing.

Finish: Bases and connecting tubes high-gloss chrome-plated, plastic powder-coated or stainless steel.

Dimensions:

Diameter of bases	50 mm
Base height	1070 mm
Diameter of connecting tubes	40 mm
Connecting tube lengths	500 mm
	1000 mm
	1500 mm
	2000 mm
Lengths of partition elements	1000 mm
	1500 mm

Assembly with lower concrete layer

Assembly of bases on fitted floors with spacers and screws of a suitable length.

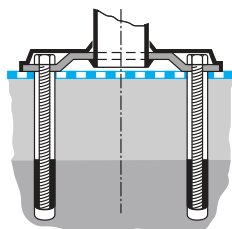

Moveable assembly

For movable barriers – floor socket for removable bases without base plates.

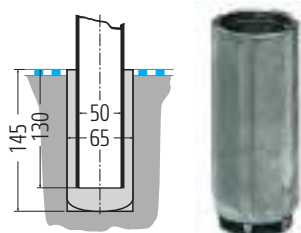

02.06 Classic customer guidance system

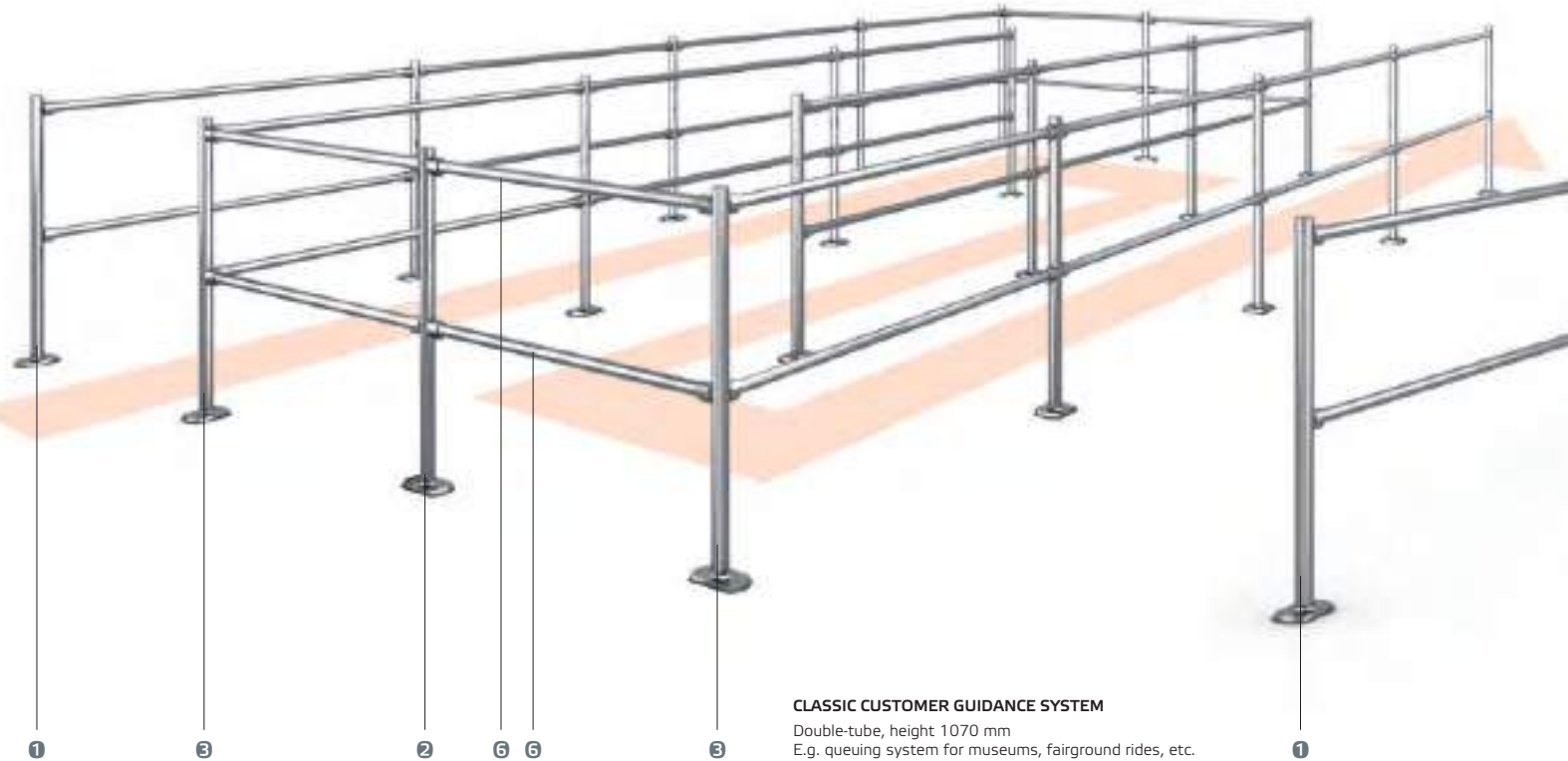

CLASSIC CUSTOMER GUIDANCE SYSTEM
 Double-tube, height 1070 mm
 E.g. queuing system for museums, fairground rides, etc.

Classic customer guidance system				
Bases with 2 tubes				
Connection sleeves	2	4 in 180°	4 in 90°, left	6 in T-arrangement
Consists of: - Base with base plate - Connection sleeve(s) Finishes* - .10 High-gloss chrome-plated - .73 Plastic powder-coated* - .09 Stainless steel				
	Prod.No.	Prod.No.	Prod.No.	Prod.No.
Plastic connection sleeves	23.10652.10/73/09-7016	23.10653.10/73/09-7016	23.04747.10/73/09-7016	23.10657.10/73/09-7016
Metal connection sleeves	23.72987.10/73/09	23.75513.10/73/09	23.04748.10/73/09	23.75517.10/73/09
Connection sleeves	2 landscape	4 in 180° landscape	4 in 90°, right	6 in T-arrangement, landscape
Consists of: - Base with base plate - Connection sleeve(s) Finishes* - .10 High-gloss chrome-plated - .73 Plastic powder-coated* - .09 Stainless steel				
	Prod.No.	Prod.No.	Prod.No.	Prod.No.
Plastic connection sleeves	23.10701.10/73/09-7016	23.07273.10/73/09-7016	23.10655.10/73/09-7016	23.10567.10/73/09-7016
Metal connection sleeves	23.10702.10/73/09	23.07386.10/73/09	23.75515.10/73/09	23.17187.10/73/09

Anthraccite grey RAL 7016 plastic connection sleeves, high-gloss chrome-plated metal connection sleeves

* Example orders: 23.10652.10 High-gloss chrome-plated
 23.10652.73 Plastic powder coating, please specify the colour required.
 23.10652.09 Stainless steel

02.06 Classic customer guidance system



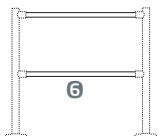

CLASSIC CUSTOMER GUIDANCE SYSTEM
with partition elements, height 1070 mm
e.g. as a guide in front of self-service counters in service stations and self-service restaurants

CLASSIC CUSTOMER GUIDANCE SYSTEM
Double-tube, height 1070 mm
Link between rooms

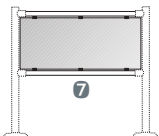
Classic customer guidance system	
Connecting tubes	
Tube diameter	40 mm
Finishes*	
- .10 High-gloss chrome-plated	
- .73 Plastic powder-coated*	
- .09 Stainless steel	
Tube lengths	Prod.No.
500 mm	23.04249.10/73/09
1000 mm	23.04017.10/73/09
1500 mm	23.04018.10/73/09
2000 mm	23.04019.10/73/09

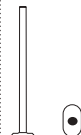
Classic customer guidance system	
Partition elements	
With acrylic glass	Tube diameter 40 / Acrylic glass 4 mm
Finishes (please specify)	
- .10 High-gloss chrome-plated	
- .73 Plastic powder-coated*	
- .09 Stainless steel	
Acrylic glass, transparent 9095	
Width	Prod.No.
1000 mm	23.16298.95
1500 mm	23.16299.95

Base	
without sleeves	
Base finishes*	
- .10 High-gloss chrome-plated	
- .73 Plastic powder-coated*	
- .09 Stainless steel	
	Prod.No.
	23.10646. 10/73/09

Moveable barriers		
	Base	Insert sleeve
Base finishes*		
- .10 High-gloss chrome-plated		
- .73 Plastic powder-coated*		
- .09 Stainless steel		
Floor sleeve		
- Aluminium die casting		
	Prod.No.	Prod.No.
	23.43342.10/73/09	23.06429.44

03 Product overview

03.01 – 03.04 Guide rails



01 CLASSIC
GUIDE RAILS



02 TECHNOLINE
GUIDE RAILS



03 STAINLESS STEEL
GUIDE RAILS



04 NX STAINLESS STEEL
GUIDE RAILS

03.05 Ram protection hoops



05 RAM PROTECTION HOOPS

03.06 Protec 3 bumper



06 PROTEC 3 BUMPER

03.07 Bumper



07 BUMPER FOR
FREEZER UNITS

03.08 - 03.09 Protectors



08 CHROME/ALUMINIUM
CORNER PROTECTORS



09 PROTECTORS FOR
SECURITY TAGS

03.10 - 03.11 Ram protection uprights / Deflector rings



10 RAM PROTECTION
UPRIGHTS



10 BOLLARDS



11 DEFLECTOR RINGS

03 Protection systems



03.01 Classic guide rails

Robust, economical and adaptable guide rail system

› Effective protection for shop fittings against damage caused by shopping trolleys

› Can be adjusted exactly to the trolley model used

› Guide rail profile in single and double-sided design



■ The **Wanzl Classic guide rails** protect the valuable shop fittings from damage, particularly that caused by shopping trolleys.

Design: Guide rails made of sturdy, anodised aluminium, plastic bumper profile on one or two sides.

Accessories: End caps, Vario corner connector, connection components, feet, angled wall mounts

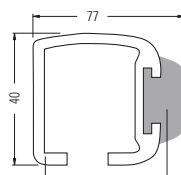

Aluminium profile Plastic bumper profile

Guide rail profile, single-sided

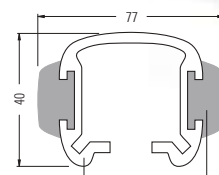

Aluminium profile Plastic bumper profile

Guide rail profile, double-sided

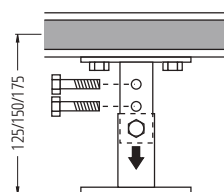

Foot, height-adjustable

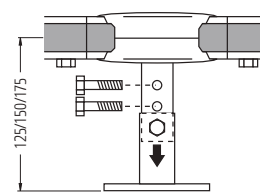

Vario corner connector, height-adjustable

03.01 Classic guide rails

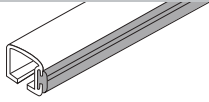
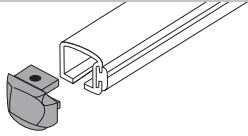
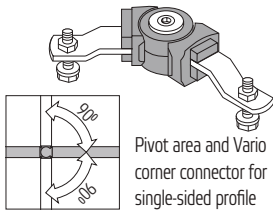
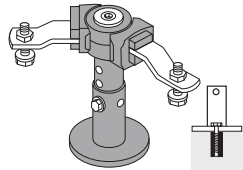
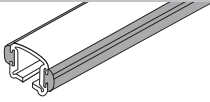
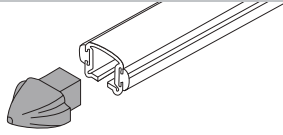
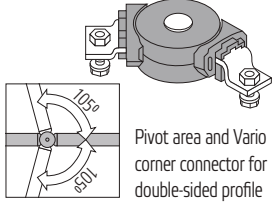
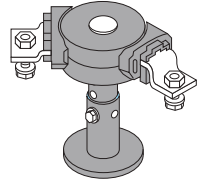
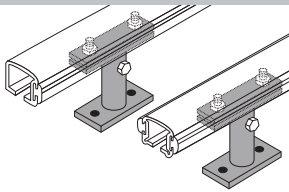
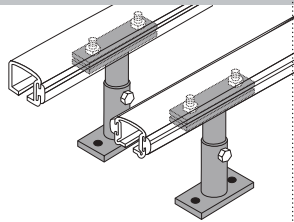
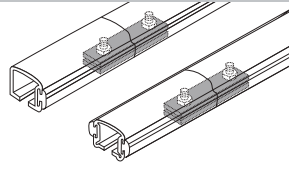
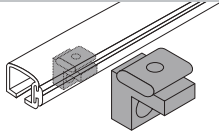
Classic guide rails – single-sided profile			
Guide rail, single-sided profile		End cap	
Prod.No.	23.32751.45	Prod.No.	23.32753.45
<p>Anodised aluminium profile with inserted, coloured plastic profile. 1 m guide rail profile, single-sided Light grey RAL 7035</p> 		<p>Polyamide, coloured Light grey RAL 7035</p> 	
Please specify the desired length. Max. length per bar 6 m. Pricing is by the full metre			
Vario corner connector		Vario corner connector, adjustable in height	
Prod.No.	23.36358.50	Prod.No.	23.36357.73
<p>Joint made of polyamide Light grey RAL 7035</p>  <p>Pivot area and Vario corner connector for single-sided profile</p>		<p>Heights 125/150/175 mm Joint made of polyamide Surface plastic powder-coated Light grey RAL 7035</p> 	
Classic guide rails – double-sided profile			
Guide rail, double-sided profile		End cap	
Prod.No.	23.05251.45	Prod.No.	23.05252.07
<p>Anodised aluminium profile with inserted, coloured plastic profile. 1 m guide rail profile, single-sided Light grey RAL 7035</p> 		<p>Polyamide, coloured Light grey RAL 7035</p> 	
Please specify the desired length. Max. length per bar 6 m. Pricing is by the full metre			
Vario corner connector		Vario corner connector, adjustable in height	
Prod.No.	23.20442.50	Prod.No.	23.20441.73
<p>Joint made of polyamide Light grey RAL 7035</p>  <p>Pivot area and Vario corner connector for double-sided profile</p>		<p>Heights 125/150/175 mm Joint made of polyamide Surface plastic powder-coated Light grey RAL 7035</p> 	
Fittings			
Foot, height-adjustable		Foot, fixed	
Prod.No.	23.05253.73	Prod.No.	23.16378.73
<p>Heights 125/150/175 mm For single and double-sided profile. Ideal installation separation max. 1 m. Surface plastic powder-coated Light grey RAL 7035</p> 		<p>Height 230 mm For single and double-sided profile. Ideal installation separation max. 1 m. Surface plastic powder-coated Light grey RAL 7035</p> 	
Connection piece		Angled wall mount	
Prod.No.	23.05254.50	Prod.No.	23.74993.44
<p>For single and double-sided profile. To connect guide rails. Surface high-gloss galvanised chrome-plated.</p> 		<p>For single-sided profile. Aluminium design incl. fixing material 1 plastic dowel S19, 1 wood screw, half-round 8 x 50.</p> 	

Installation fittings for floor installation available on request.

03.02 Technoline guide rails

Elegant and functional protection for sales areas with high requirements

- > *Simple assembly, reliable function*
- > *Infinitely adjustable to the types of shopping trolley used*
- > *Available in six different colours*





■ **Wanzl Technoline guide rails.** There is scarcely a more attractive way of protecting the shop fittings, fridges, serving counters, etc. from damage caused by shopping trolleys and by transport and cleaning devices.

Design: Guide rails with sturdy aluminium profiles; the especially hard-wearing and impact-resistant plastic bumper profile with 3 mm-thick walls is clipped on and can be replaced.

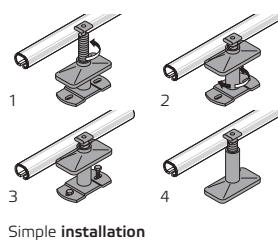
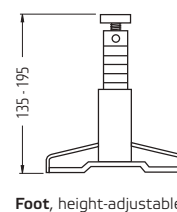
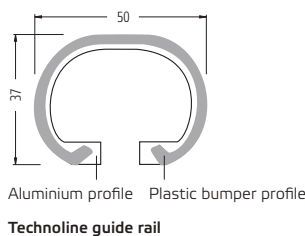
Accessories: End caps, Vario corner connectors, corner spring elements, connection pieces, feet, angled and wall mounts.

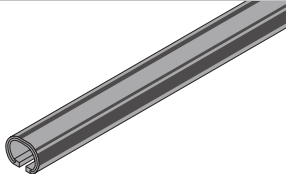

03.02 Technoline guide rails

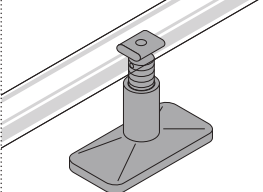
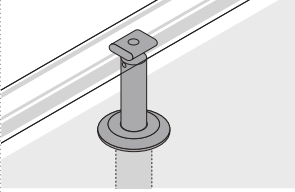
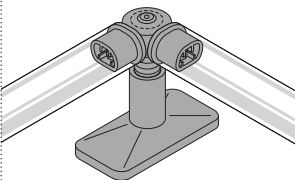
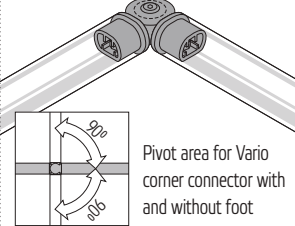
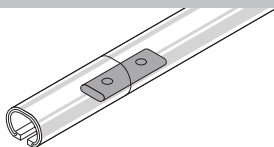
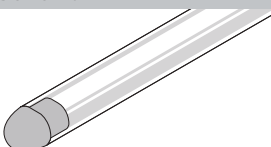
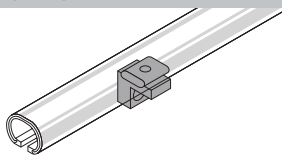
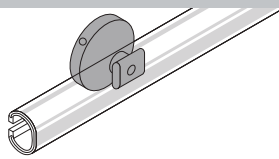
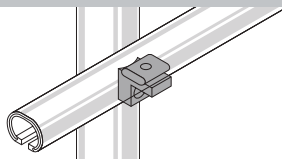
"Oval" guide rail			
<p>Prod.No. 23.69161.44</p> <p>Aluminium profile, complete with fitted plastic profile. Available in 6 attractive colours.</p> <p>Anthracite grey RAL 7016 Flame red RAL 3000 Light grey RAL 7035 Traffic green RAL 6024 Traffic blue RAL 5017 Rapeseed yellow RAL 1021</p> <p>Please specify the desired length. Max. length per bar 6 m. Pricing is by the full metre</p>		<p>Colour range</p> <p>Please order your desired colour by adding the colour code to the order number.</p> <p>Example order: Anthracite grey RAL 7016 Prod.No. 23.69161.44-7016</p>	
Foot, height-adjustable		Foot with floor socket	
<p>Prod.No. Anthracite grey RAL 7016 * 23.86622.95-7016 High-gloss chrome-plated* 23.86622.95-0719</p> <p>Foot height adjustable from 135 -195 mm High-gloss chrome-plated finish Recommended installation separation max. 1 m</p> <p>* Plastic base plate cover</p>		<p>Prod.No. Height to centre of profile 125 mm 23.25473.95 Height to centre of profile 150 mm 23.25474.95</p> <p>Problem-free, mechanical floor cleaning with removal of the guide rails. Finish: high-gloss chrome-plated. Aluminium floor sleeve with 35 mm diameter. Recommended installation separation max. 1 m</p>	
Vario corner connector with foot		Vario corner connector	
<p>Prod.No. Anthracite grey RAL 7016 23.59865.95-7016 Bright chrome-plated 0719 23.59865.95-0719</p> <p>For connections from 0° - 90°. Foot height adjustable from 135 -195 mm, high-gloss chrome-plated finish. Plastic swivel component, anthracite grey RAL 7016 With plastic base plate cover</p>		<p>Prod.No. 23.69166.07-7016</p> <p>For connections from 0° - 90°. Plastic swivel component, anthracite grey RAL 7016</p>	 <p>Pivot area for Vario corner connector with and without foot</p>
Connection piece		End cap	
<p>Prod.No. 23.89388.50</p> <p>For connection of guide rails, high-gloss galvanised, flat bar, chrome-plated.</p>		<p>Prod.No. 23.69162.10</p> <p>Die-cast zinc, high-gloss chrome-plated finish</p>	
Angled fastener for wall		Wall fixation plate	
<p>Prod.No. 23.74993.44</p> <p>Aluminium design.</p> <p>incl. fixing material 1 plastic dowel S10, 1 wood screw, half-round 8 x 50.</p>		<p>Prod.No. 23.74994.44</p> <p>Finish: high-gloss chrome-plated.</p> <p>incl. fixing material 1 plastic dowel S10, 1 wood screw, half-round 8 x 50.</p>	
Angled fastener for base			
<p>Prod.No. 23.74992.44</p> <p>Aluminium design.</p> <p>incl. fixing material 1 M8 x 30 screw</p>			

Installation fittings for floor installation available on request.

03.03 Stainless steel guide rails

Perfect protection for shop fittings against bumps from shopping trolleys

- > *Made from stainless steel and aluminium – corrosion-resistant*
- > *Rectangular or rounded feet available*
- > *Variable corner connectors from 90° - 270°*



■ **Wanzl stainless steel guide rails** effectively protect the shop fittings, fridges, service counters, etc. from damage caused by shopping trolleys and transport devices. The rounded foot construction is of particular benefit when using cleaning machines.

Design: Polished stainless steel tube. Feet and corner connectors in cast aluminium, natural or plastic powder-coated in RAL 9006 white aluminium.

Accessories: End caps, tubes curved at 90°, Vario corner connectors, connection elements.



Rectangular foot, standard heights



Optimum protection for fittings and trolleys

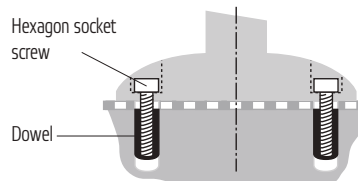

Installation for normal floor constructions supplied as standard

03.03 Stainless steel guide rails

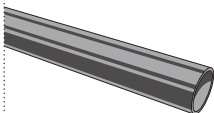
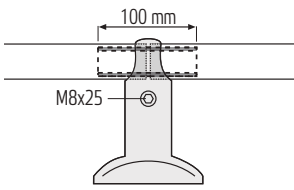
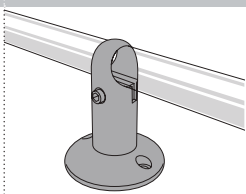
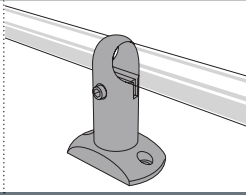
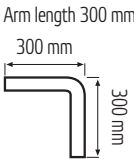
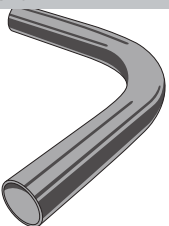
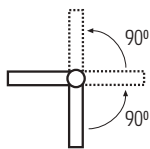
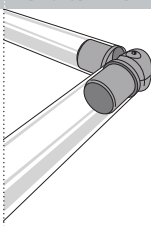
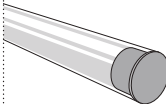
Stainless steel guide rails			
Tubes with 40 mm diameter	1 m	3 m	Connection element with 35.5 mm diameter
<p>Polished stainless steel</p> <p>Max. length per bar 3 m. Calculation by each full metre</p> 	23.04017.09	23.04020.09	<p>Prod.No. 23.21244.07</p> <p>Tube connection inside sleeve in the foot</p> 
<p>Foot - round</p> <p>Prod.No. 23.21245.44/73*</p> <p>Height 125 mm</p> <p>Cast aluminium</p> <p>Base plate diameter 117 mm</p> <p>Installation separation max. 1 m</p> 			<p>Foot - rectangular</p> <p>Prod.No. 23.21246.44/73*</p> <p>Height 125 mm</p> <p>Prod.No. 23.21247.44/73*</p> <p>Height 150 mm</p> <p>Prod.No. 23.21248.44/73*</p> <p>Height 175 mm</p> <p>Cast aluminium,</p> <p>Base plate 117 x 60 mm</p> <p>Installation separation max. 1 m</p> 
<p>Tubing diameter 40 mm curved, 90°</p> <p>Prod.No. 23.21251.09</p> <p>Polished stainless steel</p> <p>Arm length 300 mm</p>  			<p>Vario corner connector, can be adjusted from 90° - 270°</p> <p>Prod.No. 23.20905.44/73*</p> <p>Cast aluminium</p>  
<p>End cap for tube with 40 mm diameter</p> <p>Prod.No. 23.06497.07</p> <p>Plastic</p> <p>Light grey RAL 7035</p> <p>Other colours available on request</p> 			

* Example orders:
 23.21246.44 Cast aluminium, natural
 23.21246.73-9006 Plastic powder-coated
 in RAL 9006 white aluminium

03.04 NX stainless steel guide rails

Perfect appearance – perfect function

- > Quick and easy assembly
- > Coordinated exactly with the Wanzl shopping trolleys with castor diameter 125 mm
- > Made from polished stainless steel – corrosion-resistant



■ The **Wanzl NX stainless steel guide rails** perfectly protect shop fittings and fridges against bumps from shopping trolleys.



Design: Connecting tubes, T-connectors, end and corner bows made from polished stainless steel tubing diameter 40 x 2 mm with welded-on feet. Variable corner connector for connections from 90° to 270°, surface with black plastic powder coating. Push-fit connector and end cap made from black plastic. Stainless steel floor flanges.

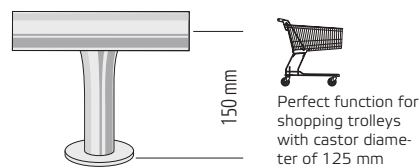

Collision height for shopping trolleys

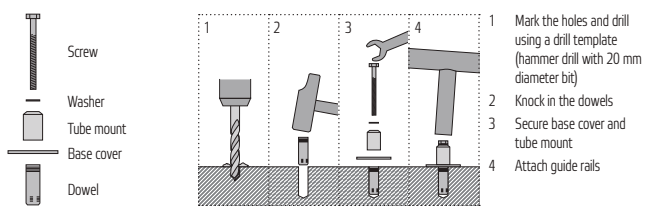

Installation for normal floor constructions, fixing materials supplied as standard

03.04 NX stainless steel guide rails

NX stainless steel guide rails			
Connecting tubes			
Prod.No.	23.64189.09		
Connecting tube 1 m With 1 base arranged asymmetrically, length 995 mm			
Prod.No.	23.64076.09		
Connecting tube 2 m With 2 bases arranged asymmetrically, length 1995 mm			
Prod.No.	23.63963.09		
Connecting tube 3 m With 3 feet arranged asymmetrically, length 2995 mm			
T-connector			
Prod.No.	23.64415.09		
T-connector short With 1 foot in centre, length 190 mm			
Prod.No.	23.64302.09		
T-connector long With 1 foot in centre, length 1800 mm			
End bow		Corner bow 90°	
Prod.No.	23.77975.09	Prod.No.	23.63511.09
Corner bow 135°		Vario corner connectors 90° -270°	
Prod.No.	23.89049.09	Prod.No.	23.89162.73
Floor fastening		Floor fastening	
Prod.No.	23.88597.95	Prod.No.	23.88710.95
For end bow		For connecting tubes and corner bows	
Only as required		Only as required	
Push-fit connector		End cap for tube with 40 mm diameter	
Prod.No.	23.21244.07	Prod.No.	01.55962.07
Black plastic		Black plastic Other colours available on request	

03.05 Ram protection hoops

Can be used effectively in many areas

- > Quick and easy assembly
- > Coordinated exactly with the Wanzl shopping trolleys with castor diameter 125 mm
- > Made of steel tubing – high-gloss chrome-plated or stainless steel finish



■ The **Wanzl ram protection hoops** protect shop fittings, fridges, cash desks, doors, radiators etc. against damage caused by shopping trolleys.

Design: Barrier and corner bar made of steel tubing, diameter 40 x 2 mm. On-floor installation either screwed using steel sleeves or pinned using floor sleeves. High-gloss chrome-plated or stainless steel surface.

Operation: In the design with floor sleeve, the barrier and corner bar can be removed in order to clean the floor. The floor sleeves are then sealed using the plastic plugs provided during cleaning. This is of particular benefit for perfect cleaning when using cleaning machines.

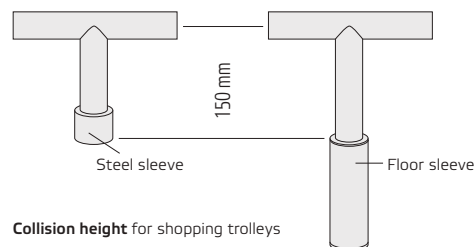

Perfect function for shopping trolleys with castor diameter of 125 mm



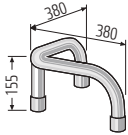
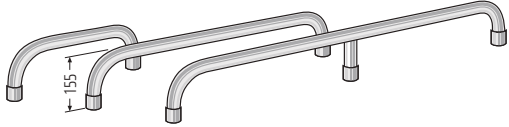

03.05 Ram protection hoops

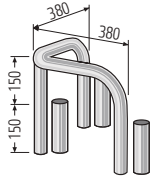
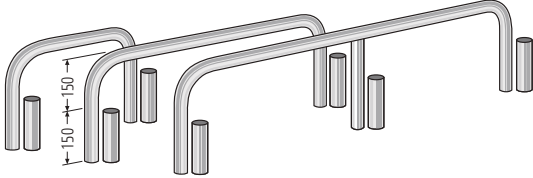
Ram protection hoops				
Fixed to the floor with steel sleeves				
	Corner bar	Barrier		
Tube with 40 mm diameter incl. screws and dowels				
Finish	Prod.No.	Length 500 mm Prod.No.	Length 1000 mm Prod.No.	Length 1500 mm Prod.No.
High-gloss chrome-plated	23.80392.10	23.80393.10	23.80394.10	23.80395.10
Stainless steel	23.80392.09	23.80393.09	23.80394.09	23.80395.09

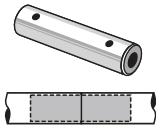
Ram protection hoops				
Floor mounting with floor sleeves				
	Corner bar	Barrier		
Tube with 40 mm diameter				
Finish	Prod.No.	Length 500 mm Prod.No.	Length 1000 mm Prod.No.	Length 1500 mm Prod.No.
High-gloss chrome-plated	23.80396.10	23.80397.10	23.80398.10	23.80399.10
Stainless steel	23.80396.09	23.80397.09	23.80398.09	23.80399.09

Accessories	
Prod.No.	00.85076.09
Bar connector, for constructing intermediate lengths (reducing) Length 150 mm, diameter 35.5 mm	

As required	
Prod.No. 23.80387.09	Prod.No. 01.63157.07
Complete floor sleeve for corner bar and barrier	Plastic plugs to seal the floor sleeve
	

03.06 Protec 3®

Bumper – robust, functional and attractive

- > Effective protection for freezer cabinets and shop fittings
- > Also ideal for logistics and storage areas
- > Recommended when using several models of shopping trolley that vary in size



■ The **Wanzl ProTec 3 bumper** provides effective protection for shop fittings, fridge units, and logistics and warehouse equipment against damage caused by collisions with shopping and transport trolleys, light-weight forklift trucks and cleaning machines.

Design: Bumper made of profiled galvanised sheet steel. Fasteners, corners and end caps made of black elastomer. Floor fastening foot made of sheet steel, galvanised with colourless stove-enamel finish.

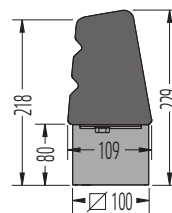

protection height



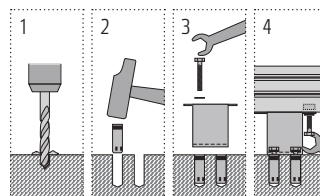
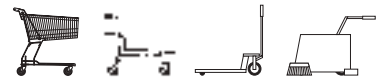

Perfect function with



- 1 Mark the holes and drill using a drill template (hammer drill with 20 mm diameter bit)
- 2 Knock in both dowels
- 3 Secure the base
- 4 Position bumper profile on the installed feet and bolt in place.

Installation with normal floor constructions, mounting material supplied as standard

03.06 Protec 3®

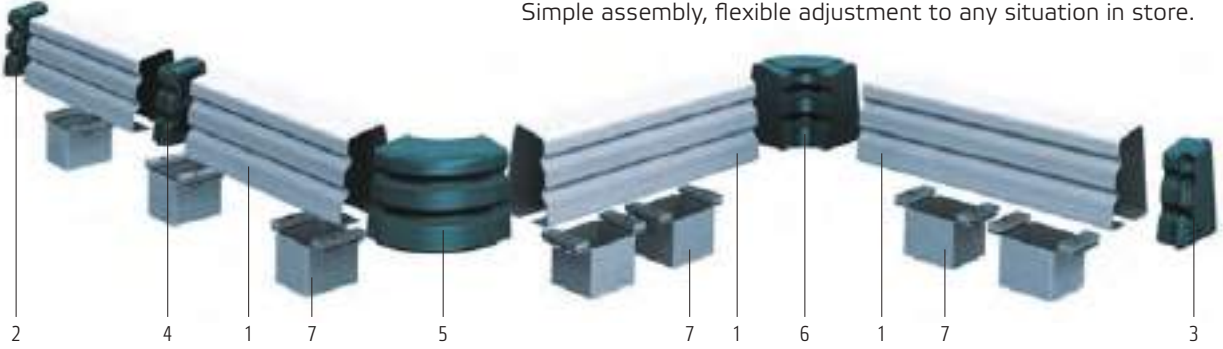
Ram protection hoops					
Bumper profile		End cap, left		End cap, right	
Prod.No.	23.60100.50	Prod.No.	23.60106.07 9005	Prod.No.	23.60107.07 9005
Profile 1 m, length 3 m		Elastomer, black, incl. fixing material		Elastomer, black, incl. fixing material	
	1		2		3
Connector 180°		Outer corner 90°		Inner corner 90°	
Prod.No.	23.60105.07 9005	Prod.No.	23.60103.07 9005	Prod.No.	23.60104.07 9005
Elastomer, black, incl. fixing material		Elastomer, black, incl. fixing material		Elastomer, black, incl. fixing material	
	4		5		6
Floor fastening base					
Prod.No.	23.60108.51				
Galvanised and stove-enamel finish sheet steel.					
Recommended installation separation max. 1 m	7				
Bumper protection with a system					
Simple assembly, flexible adjustment to any situation in store.					
					

03.07 Bumper for freezer units

Protection systems for AHT freezer units, Paris and Miami models

- > Reinforced corner elements
- > Side and centre elements are especially robust
- > With ventilation and exhaust slits



■ The **Wanzl bumper for freezer units** effectively protects groups of AHT freezer units* against damage caused by collisions with shopping and transport trolleys, light-weight forklift trucks and cleaning machines.

* Bumpers for freezer units from other manufacturers available on request.

Design: Sheet steel bumper with high-gloss chrome-plated finish. Especially robust corner elements, centre and side elements drilled for optimal ventilation of the cooling units, in accordance with the specifications from the freezer unit's manufacturer.



protection height

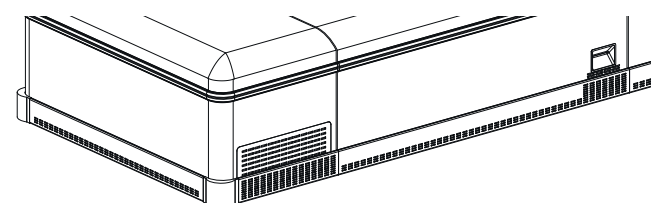

Ventilation slits precisely adapted to the freezer units

03.07 Bumper for freezer units

Bumper for AHT freezer units			
Package for unit at the end of the line	for Paris model	for Miami model	
Prod.No.	23.83875.10	23.12913.10	
1 bumper centre element 1 corner element right 1 corner element left 1 side element on the right, short 1 side element on the left, short Incl. installation fittings			
Side element for	Unit in a line 1450 mm	Unit in a line 2100 mm	Unit in a line 2500 mm
Prod.No.	23.07602.10	23.83873.10	23.83874.10
1 side element Incl. installation fittings			
End unit package for	Units in a line 1450 mm	Units in a line 2100 mm	Units in a line 2500 mm
Prod.No.	23.07603.10	23.83872.10	23.83871.10
1 bumper centre element 1 corner element right 1 corner element left 1 side element on the right 1 side element on the left Incl. installation fittings			

03.08 Chrome or aluminium corner protectors

To protect exposed corners, fittings and systems

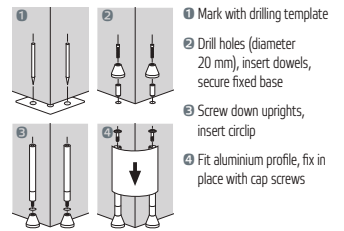

- > **Chrome:** made from sturdy sheet steel, easy to assemble
- > **Aluminium:** made from robust aluminium profile with elegant fixed base
- > Available in two heights

■ With **Wanzl corner protectors**, you can protect exposed corners on walls, shop fittings, cash desks and fridges.

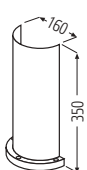

Design: Sturdy corner protector made from sheet steel, high-gloss chrome-plated surface.

Design: Anodised natural aluminium profile with 4 mm wall thickness. Sturdy fixed base and upright made from steel tube, high-gloss chrome-plated finish.

Chrome corner protector		
Height	350 mm	500 mm
Prod. No.	23.62003.10	23.62004.10
High-gloss chrome-plated finish		

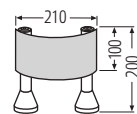
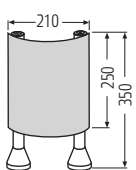
Aluminium corner protector		
Height	200 mm	350 mm
Prod. No.	23.30319.95	23.30320.95
Natural anodised and high-gloss chrome-plated finish		

03.09 Protector for security tags

This keeps security tag systems functioning reliably

- > *High resistance level*
- > *No shielding the function of the security tag system*
- > *Fast and economical assembly*



■ The **Wanzl protectors for security tags** protect your valuable security tag systems and yourself against inventory differentials. Attractive design for all fields.

Design: Bases made of steel tubes with base plate. Protectors made from acrylic glass. Casing made from sturdy welded steel.

Protector for security tags	
Dimensions	Depending on the EAS antenna used
Prod.No.	On request
Housing and base made of steel, high-gloss chrome-plated finish	

03.10 Ram protection uprights/bollards

Protection and guidance at passages, automatic doors and gates, etc.

- > Made from robust stainless steel
- > Fixing with base plate or assembly plate
- > Available in three different diameters



■ **Wanzl ram protection uprights/bollards** for protection and guidance at passages, automatic doors and gates, etc. Damage to buildings and devices caused by transport trolleys and light-weight forklift trucks is effectively reduced.

Design: High-grade steel. Ram protection upright with 50 mm diameter, with base plate and square base plate cover. Bollards with 80 mm and 120 mm diameter, with concealed, internal assembly plate.

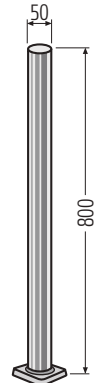
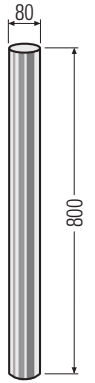
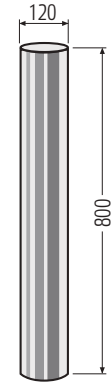

	Ram protection upright	Bollard	
	Diameter 50 mm with base plate	Diameter 80 mm with assembly plate	Diameter 120 mm with assembly plate
Prod.No.	23.94418.09-0000	23.94419.09-0000	23.94420.09-0000
Height 800 mm			
Incl. installation fittings			

03.11 Deflector rings

Reliable protection in the event of careless handling of shopping trolleys

- > Shock-absorbing plastic
- > Simple assembly, retrofitting possible
- > Available in three different inner diameters





■ The **Wanzl deflector rings** effectively protect customer guidance systems – particularly designs with coloured plastic coating – and keep your store looking great in the long term. Deflector rings reliably protect bases, barriers and entrance systems against careless handling of shopping trolleys.

Design: Sturdy, shock-absorbing plastic. Simple assembly with just 2 screws at any height. Problem-free retrofitting to systems supplied previously.

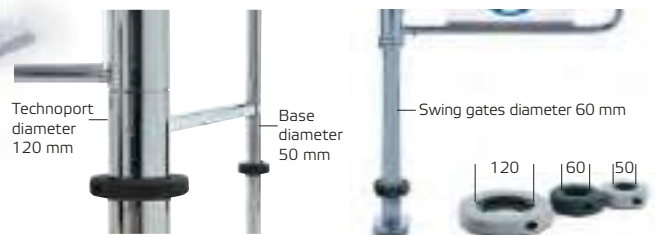
Standard colours: Anthracite grey RAL 7016 and light grey RAL 7035. Special colours available on request.



Deflector rings			
	Internal diameter 50 mm	Internal diameter 60 mm	Internal diameter 120 mm
Prod.No.	23.88983.07-7016/7035*	23.88984.07-7016/7035*	23.89464.07-7016/7035*
Colour code*	RAL 7016 anthracite grey RAL 7035 light grey		
Incl. installation fittings			

* Example orders:
23.88983.07-**7016** Anthracite grey RAL7016
23.88983.07-**7035** Light grey RAL7035

04 Product overview

04.01 - 04.02 N exits



01 N EXIT
STANDARD



02 N EXIT
HEIGHTS 1400 AND 2000

04.03 - 04.04 Pallet passages



03 MOTOR-DRIVEN
PALLET PASSAGE



04 MECHANICAL PALLET
PASSAGE

04.05 - 04.09 Mechanical checkout barriers



05 CLASSIC CHECKOUT
BARRIER



06 TANDEM CHECKOUT
BARRIER



07 RP/RPS CHECKOUT
BARRIER



08 S AND FS CHECKOUT
BARRIERS



09 SECURITY CHECKOUT
BARRIER

04.10 - 04.11 Electronic checkout barriers/swing gates



10 MGATE



11 EGATE CHECKOUT

04.12 Checkout Manager Pro



12 CHECKOUT MANAGER
PRO

04 Barriers



04.01 N exit

Safety for your customers in the event of danger

- › *Opening in the exit direction*
- › *Secure solution for emergency exits and escape routes, etc.*
- › *Available with an optional alarm function*

Bases for direct fixation (without base plate) and adapter see page 155



N EXIT

With standard swivel barrier as an emergency exit

04.01 N exit

■ **Wanzl N exit.** No need to panic. With this tried-and-tested building block from Wanzl's customer guidance range, you're always on the safe side – as are your customers.

Design

Sturdy construction from steel tube. Swivel barriers in standard or high design, high design extendable for variable access widths. Finish: high-gloss chrome-plated. Plastic info signs, including set of stickers. Panic function on both sides.

Panic function on both sides

Opens when a certain pressure is applied in both directions. The emergency exit direction or the escape route is defined by affixing the set of stickers.

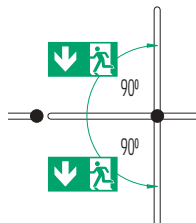

Function

The swivel barrier open to 90° when a certain pressure is applied in the direction of escape in the event of panic. The escape route is cleared. After the swivel barrier has been pressed back into the initial position, the system is ready for operation once again.

N exit, swivel barrier as standard

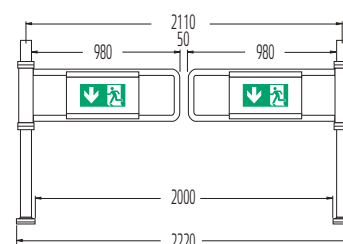
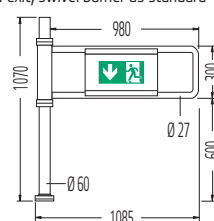

N exit, swivel barrier in high design

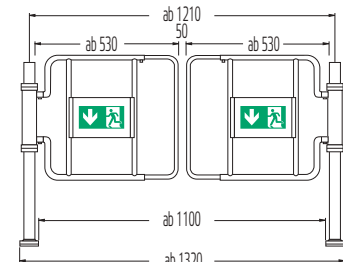
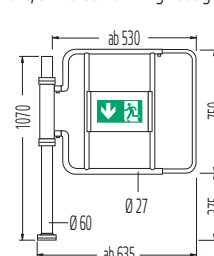

Safety

N exits comply with the guidelines of the Equipment Safety Act [Gerätesicherheitsgesetz]. As a result, official safety requirements are satisfied.



N exit		
Swivel barrier	Standard	High design
Width	980 mm	Extendable from 530 mm**
Prod.No.	23.02791.10/09/73-V001*	23.02795.10/09/73-V001*
Designs	High-gloss chrome-plated, stainless steel or plastic powder-coated	
<p>Set of stickers Self-adhesive film with emergency exit symbol and "no entry" symbol</p>		<p>** Please specify installation dimensions on site</p>
Accessories		
Acoustic panic alarm	98.73142.00	
Notifies the personnel when the anti-panic feature is triggered by unauthorised persons		

* Example orders: 23.02791.10-V001 High-gloss chrome-plated
 23.02791.09-V001 Stainless steel
 23.02791.73-V001 Plastic powder-coated, please specify colour required.

04.02 N exit 1400/2000

Flexible and safe in two heights: 1400 mm and 2000 mm

- › *Opens in the exit direction with a certain pressure*
- › *Secure solution for emergency exits and escape routes, etc.*
- › *For access widths of 745 to 2220 mm*



N EXIT
Height 1400 mm, as emergency exit

04.02 N exit 1400/2000

Design

Sturdy construction from steel tube. Swivel barrier with support wheel, extendable. Finish: high-gloss chrome-plated. Roller centring plate, transparent acrylic glass pane in five widths, can be shortened, including set of stickers. Panic function on both sides.

Panic function on both sides

Opens when a certain pressure is applied in both directions. The emergency exit direction or the escape route is defined by affixing the set of stickers.

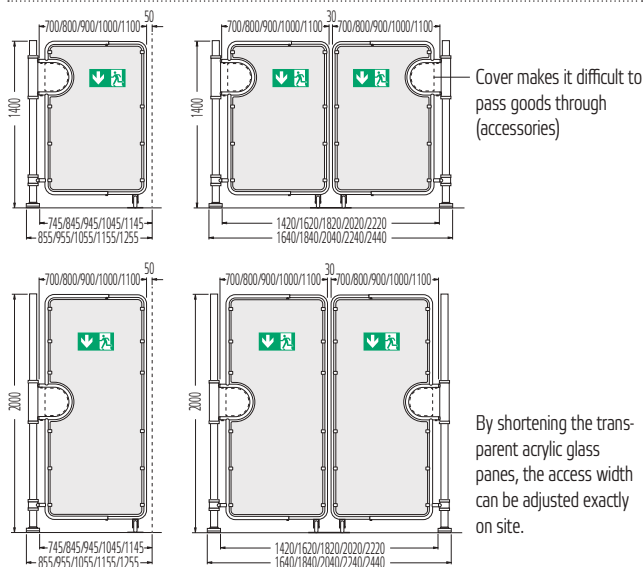
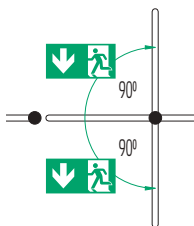

Function

The swivel barrier opens to 90° when a certain pressure is applied in the direction of escape in the event of panic. The emergency exit is cleared. After the swivel barrier has been pressed back into the initial position, the system is ready for operation once again.

Safety

N exits 1400/2000 comply with the guidelines of the Equipment Safety Act. As a result, official safety requirements are satisfied.



N exit 1400/2000				
Height	1400		2000	
Swivel arm length	Single system	Double system	Single system	Double system
700	23.02765.10-V003	On request	On request	On request
800	On request	On request	On request	On request
900	23.02765.10-V002	On request	23.02761.10-V001	23.02762.10-V001
1000	On request	On request	On request	23.02762.10-V002
1100	23.02765.10-V001	23.02766.10-V001	23.02761.10-V004	23.02762.10-V003
Design: high-gloss chrome-plated. Plastic powder coating or stainless steel on request.				
<p>Set of stickers self-adhesive film with emergency exit symbol and "no entry" symbol</p>				
Accessories				
Panel	23.24670.95			
Makes it difficult to pass goods through				
Made from transparent acrylic glass incl. fixing material				
Acoustic panic alarm	98.06668.95			
Notifies the personnel when the anti-panic feature is triggered by unauthorised persons				

04.03 Motor-driven pallet passage

Reliably steer the movement of goods

- › Opening to the left or right with tried-and-tested technology
- › Opening pulse emitted by control panel or remote control
- › Secure solution for goods handling, etc.

Bases for direct fixation (without base plate) and adapter see page 155



MOTOR-DRIVEN PALLET PASSAGE
With Classic partition system

04.03 Motor-driven pallet passage

■ These **Wanzi pallet passages** are modern gate systems for modern stores. They are electrically-controlled, open quickly and reliably and, above all, save time when it comes to passing through with forklift trucks.

Design

Upright and swivel barrier made from steel tubing, high-gloss chrome-plated, coloured plastic powder-coated or stainless steel*. Pivot mechanism fully integrated in the upright – provides a particularly high level of injury protection. Notice sign made of transparent acrylic glass.

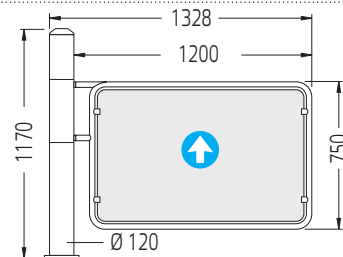

Function

Opens and closes with a signal from the control panel, button or, particularly conveniently, the remote control you carry with you.

Standard technical equipment

- Max. operating voltage of 24 V DC for the highest levels of safety.
- Motor-driven pallet passages comply with both national and international safety requirements.
- Freely programmable opening time, the system then closes again automatically.
- Direction of opening can be adjusted on-site.
- Adapter for external opening sensors.
- High resistance with anti-panic feature.

Accessories

Control panel, remote control.

Motor-driven pallet passage		Accessories		
	Opening to the left	Opening to the right	Control panel	Remote control set
Prod.No.	23.63086.10/09/73*	23.63085.10/09/73*	98.72773.00	98.74468.00
Pallet passage upright with swivel barrier and information sign				
Designs High-gloss chrome-plated Plastic powder coating				

* Example orders: 23.63086.10
23.63086.09
23.63086.73
High-gloss chrome-plated
Stainless steel
Plastic powder-coated,
colours available upon request.

04.04 Mechanical pallet passage

For Euro pallets or large containers on hand-lift trucks and forklifts

- > *Easy to use*
- > *Swivel arm is opened mechanically*
- > *Swivel arm with support roller*



MECHANICAL PALLET PASSAGE
Opening to the left



MECHANICAL PALLET PASSAGE
Opening to the right



MECHANICAL PALLET PASSAGE
In both directions

04.04 Mechanical pallet passage

■ **Mechanical pallet passages** release exactly the width that hand-lift trucks and forklifts with Euro pallets require to pass through. Passage with transport trolleys, large containers or for personnel is also possible.

Design

Sturdy steel tube design with support castor. Finish: high-gloss chrome-plated. Plastic sign, printed on both sides.

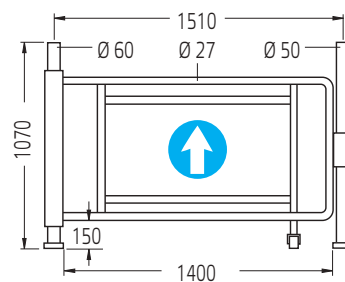

“Both sides” function

The door is held closed using a lock with a sprung fixing roller, and can be opened in both directions by applying counter-pressure.

“Right and left opening” function

The door is unlocked with a standard cylinder lock (integration in locking system possible) and can then be opened in the appropriate direction.

As required

Individual info sign, white

↑ Front, ⚡ back, 990 x 490 x 4 mm

Prod.No. 00.60809.07

Plastic profiles (set)

Prod.No. 00.41526.07

Mechanical pallet passage			
	In both directions	Opening to the left	Opening to the right
Prod.No.	23.68827.10	23.45475.10	23.45460.10
Base with swivel barrier and info sign, counter base with closure leaf			
Design High-gloss chrome-plated			

04.05 Classic checkout barriers

So everything adds up at the checkout

- › Lockable and can be opened in both directions
- › Extendable arms for precise adaptation to access width
- › Anti-panic feature as standard

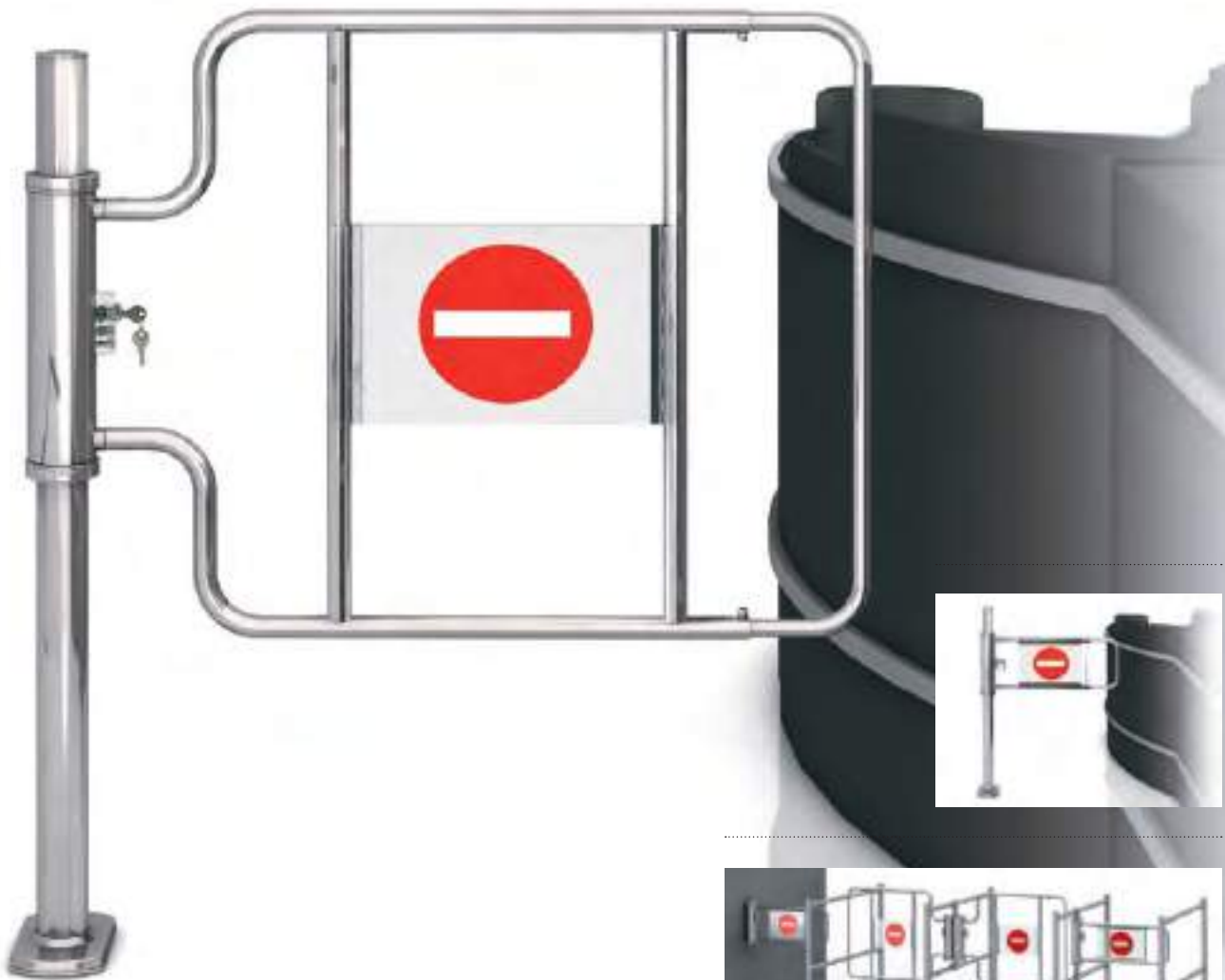

LOCKABLE CHECKOUT BARRIER
High model with base

Application examples

04.05 Classic checkout barriers

■ **Wanzl checkout barriers** are tried-and-tested, reliable components for the checkout area. Clear signals and reliable barriers control the flow of customers and make shoplifting considerably more difficult. Customers can only leave the store via manned tills.

Design

Sturdy steel tube. Info sign made of plastic, with "no entry" symbols printed on both sides, with protection profile as standard. Lock integrated in plastic housing. High-gloss chrome-plated or coloured plastic powder-coated finish.

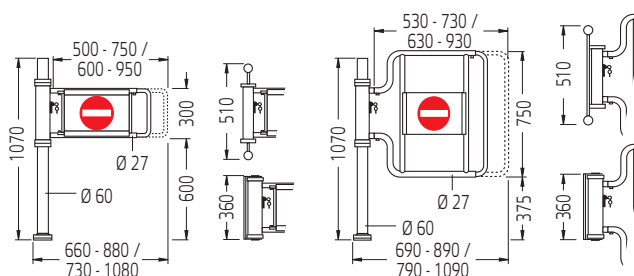

Function

Once the checkout barrier has been unlocked, the gate can be pivoted in either direction and always locks in the 90° position. Anti-panic feature as standard.

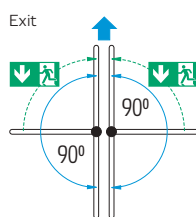

Pull-out gate

Extendable for adaptation to access widths.

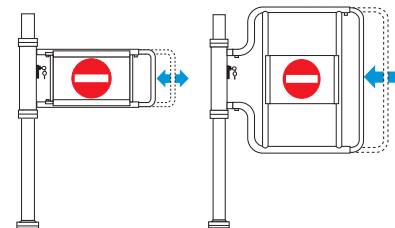

Space-saving assembly options

Checkout barrier installed between connecting tubes

Ideal for checkout zones with restricted space available.

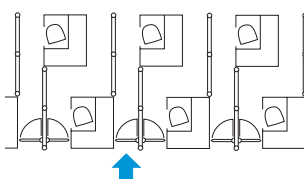

Installation with 90° angle adapter

Base installation in front of the cash desk. 2 adapters are required per swivel barrier.

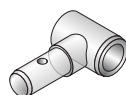

Finish: high-gloss chrome-plated.

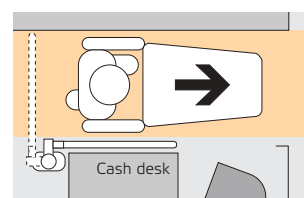

90° angular adapter, 1 unit
Prod.No. 23.08415.10



As required

Individual info signs,  front,  rear, and plastic profiles for installation on request.

04.05 Classic checkout barriers

"Lockable" checkout barrier - standard design				
Assembly with base	Arm extendable from 500 - 750 mm		Arm extendable from 600 - 950 mm	
	Base, left	Base, right	Base, left	Base, right
Prod.No.	23.33005.10-V001*	23.33005.10-V002*	23.33005.10-V003*	23.33005.10-V003*
<p>Metal base plate cover Exit Emergency exit direction Anti-panic feature as standard</p>				
between connecting tubes	Tube fixture, left	Tube fixture, right	Tube fixture, left	Tube fixture, right
Prod.No.	23.33007.10-V001*	23.33007.10-V002*	23.33007.10-V003*	23.33007.10-V003*
<p>Exit Emergency exit direction Anti-panic feature as standard</p>				
between connecting tubes	Double tube fixture		Double tube fixture	
Prod.No.	23.33011.10-V001*		23.33011.10-V002*	
<p>Exit Exit Emergency exit direction Emergency exit direction Anti-panic feature as standard</p>				
at the checkout	Flange, left	Flange, right	Flange, left	Flange, right
Prod.No.	23.33009.10-V001*	23.33009.10-V002*	23.33009.10-V003*	23.33009.10-V004*
<p>Exit Emergency exit direction Anti-panic feature as standard</p>				

* Example orders: 23.33009.10-V001 High-gloss chrome-plated
Plastic powder coating and stainless steel on request.

Only as required:
Lock complete with handle part for "lockable" checkout barrier
Key for "lockable" checkout barrier

Prod.No. 00.22439.07
Prod.No. 00.49321.00

04.05 Classic checkout barriers

"Lockable" checkout barrier - high design				
Assembly with base	Arm extendable from 530 - 730 mm		Arm extendable from 630 - 930 mm	
	Base, left	Base, right	Base, left	Base, right
Prod.No.	23.33005.10-V005*	23.33005.10-V006*	23.33005.10-V007*	23.33005.10-V008*
<p>Metal base plate cover</p> <p>Exit</p> <p>Emergency exit direction</p> <p>Anti-panic feature as standard</p>	<p>Emergency</p>	<p>Emergency</p>	<p>Emergency</p>	<p>Emergency</p>
between connecting tubes	Tube fixture, left	Tube fixture, right	Tube fixture, left	Tube fixture, right
Prod.No.	23.33007.10-V005*	23.33007.10-V006*	23.33007.10-V007*	23.33007.10-V008*
<p>Exit</p> <p>Emergency exit direction</p> <p>Anti-panic feature as standard</p>	<p>Emergency</p>	<p>Emergency</p>	<p>Emergency</p>	<p>Emergency</p>
between connecting tubes	Double tube fixture		Double tube fixture	
Prod.No.	23.33011.10-V003*		23.33011.10-V004*	
<p>Exit</p> <p>Exit</p> <p>Emergency exit direction</p> <p>Emergency exit direction</p> <p>Anti-panic feature as standard</p>	<p>Emergency</p>	<p>Emergency</p>	<p>Emergency</p>	<p>Emergency</p>
at the checkout	Flange, left	Flange, right	Flange, left	Flange, right
Prod.No.	23.33009.10-V005*	23.33009.10-V006*	23.33009.10-V007*	23.33009.10-V008*
<p>Exit</p> <p>Emergency exit direction</p> <p>Anti-panic feature as standard</p>	<p>Emergency</p>	<p>Emergency</p>	<p>Emergency</p>	<p>Emergency</p>

* Example orders: 23.33005.10-V005 High-gloss chrome-plated
Plastic powder coating and stainless steel on request.

Only as required:
Lock complete with handle part for "lockable" checkout barrier
Key for "lockable" checkout barrier

Prod.No. 00.22439.07
Prod.No. 00.49321.00

04.06 Tandem checkout barriers

A checkout barrier with a double function for two tills

- › *Intelligent checkout barrier solution for space-saving checkout installation*
- › *Extendable arms for precise adaptation to access width*
- › *With anti-panic feature as standard*

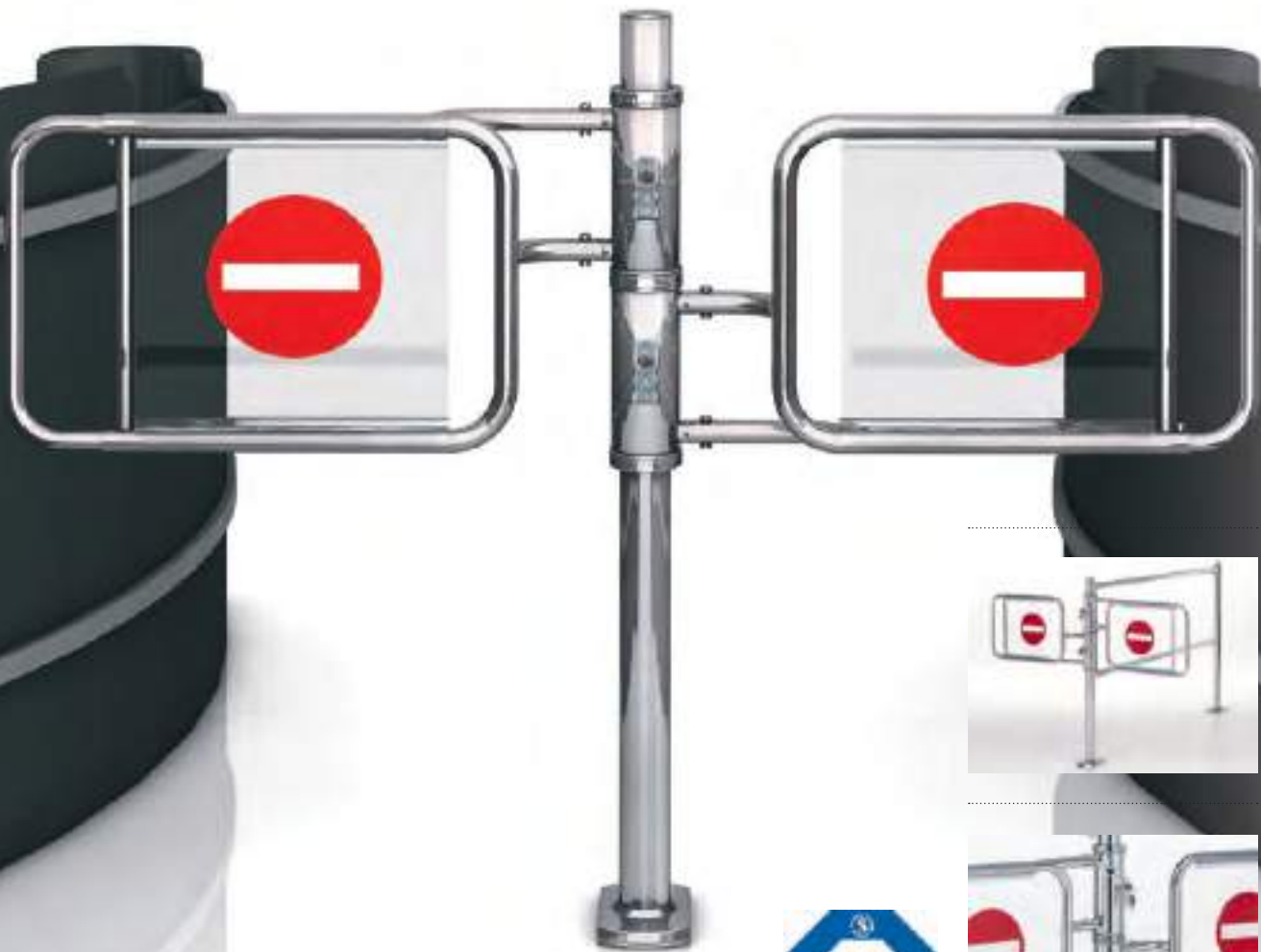

TANDEM CHECKOUT BARRIER
Opening in both directions



04.06 Tandem checkout barriers

■ **Wanzl Tandem lockable checkout barrier.** The compact and secure solution between two cash desks. Optimum use is made of the available space, and the access widths are fully retained. The Tandem checkout barrier is also available as an individual solution.

Design

Base made of steel tube. Pivoting parts with lock as standard. Extending swivel barrier. High-gloss chrome-plated or coloured plastic powder-coated finish. Info signs optionally in transparent white plastic or acrylic glass.

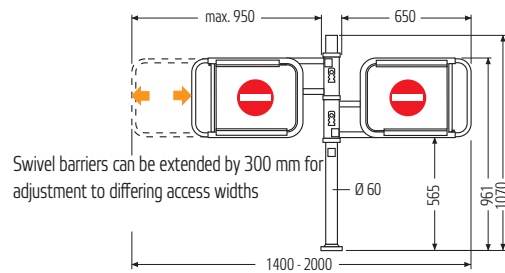

Function

The two checkout barriers can be operated independently of one another.

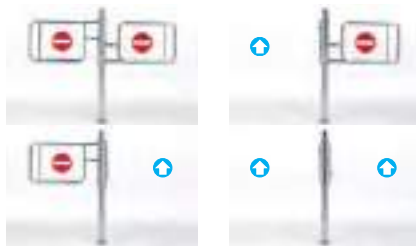

Anti-panic feature as standard

The opening direction and emergency exit direction is always in the direction of the exit.

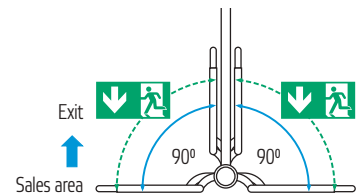

Assembly examples

The optimum installation position is at the start of the checkout's conveyor belt. With the Wanzl Classic customer guidance system, other positions are also possible.

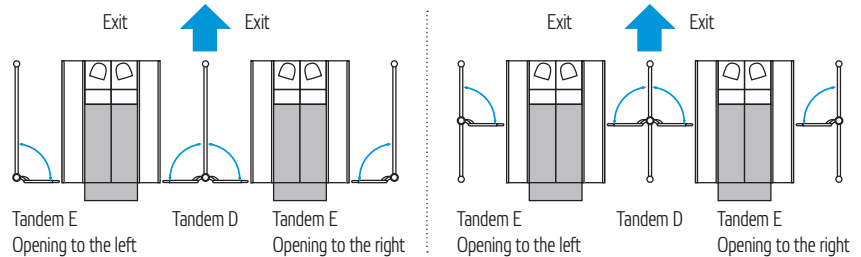

Tandem checkout barriers			
	Tandem D	Tandem E	
with base	Opening in both directions	Opening to the left	Opening to the right
With sign, white	23.24432.10/73*	23.24431.10/73*	23.24430.10/73*
With transparent plastic info sign	23.24429.10/73*	23.24427.10/73*	23.24428.10/73*
Delivery incl. fixing material			

* Example orders: 23.24431.10 High-gloss chrome-plated
23.24431.73 Plastic powder-coated,
Colours and stainless steel design on request.

Only as required:
Lock complete with handle part for "lockable" checkout barrier
Key for "lockable" checkout barrier
Prod.No. 00.22439.07
Prod.No. 00.49321.00

04.07 RP/RPS checkout barrier

Easy to use – reliable operation

- > *Light-weight checkout barrier for installation on the cash desk or wall*
- > *Pull-out gate for precise adaptation to access width*
- > *With anti-panic feature as standard*



RPS CHECKOUT BARRIER
With lock

04.07 RP/RPS checkout barrier

■ The **Wanzl RP and RPS checkout barriers** give you greater control over inventory differentials. The checkout barriers are available in two designs, as the respective checkout situation requires – perfect for security at unmanned checkouts.

Design

Sturdy steel tube barrier, extendable to fit various access widths. Available without (RP) or with lock (RPS). High-gloss chrome-plated or coloured plastic powder-coated finish. Info signs optionally in transparent white plastic or acrylic glass.

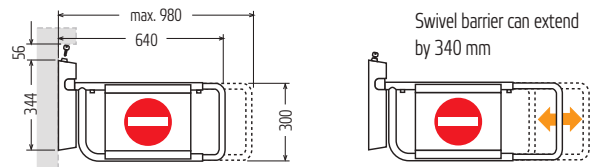

Anti-panic feature as standard

The checkout barrier can be opened in the direction of the exit when a certain amount of counter-pressure is applied.

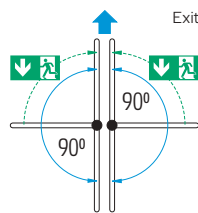

Lock

RPS cylinder lock



RP operation

After lifting the swivel arm, the checkout barrier can be opened in both directions and stops automatically in the 90° position.

RPS operation

The swivel arm is unlocked with the key. After lifting the swivel arm, the checkout barrier can be opened in both directions and stops automatically in the 90° position. In this position, the key can be used to lock the swivel arm.

Checkout barriers	RP	RPS
Features	Without lock	With lock
With sign, white	23.00110.10/73*	23.00120.10/73*
With sign, acrylic glass	23.00070.10/73*	23.00075.10/73*
For installation on the wall or checkout desk		
Accessories: fixing set		
Prod.No.	23.30983.10	
For installation on the partition base		

* Example orders: 23.00110.10 High-gloss chrome-plated
23.00110.73-7016 Plastic powder coating in anthracite grey RAL 7016

Only as required:
Lock complete with key for RPS checkout barrier

Prod.No. 93.14380.10

04.08 S and FS checkout barriers

Greater security at the checkout

- > Locks automatically in the 90° position
- > Pull-out gate for precise adaptation to access width
- > With anti-panic feature on both sides as standard



FS CHECKOUT BARRIER
On the base

Application examples - S checkout barriers

04.08 S and FS checkout barriers

■ The **self-locking Wanzl S and FS checkout barriers** give you greater control over inventory differentials. The checkout barriers lock automatically and cannot be opened by customers. That means optimum security at unmanned checkouts.

S design checkout barriers

Installation with base, at the checkout table or between connecting tubes. Pivoting parts with lock as standard. Extending swivel barrier. High-gloss chrome-plated or coloured plastic powder-coated finish. Info signs - white plastic or transparent acrylic glass.

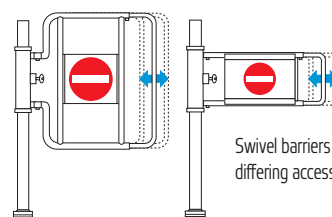

Swivel barriers can be extended by 300 mm for adjustment to differing access widths

FS design checkout barriers

Assembly with high base. Pivoting parts with lock as standard. Adjustable-length swivel barrier with integrated support roller. High-gloss chrome-plated or coloured plastic powder-coated finish. Transparent acrylic glass panels, with no entry symbols on both sides.

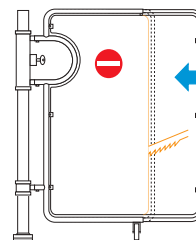

Swivel barrier can be shortened to the required passage width. The acrylic glass filling is shortened on-site as required.

Design pend.

Optimum security

- High design to prevent people climbing over
- Difficult to pass goods through
- Significant reduction in number of thefts



Function

After releasing the checkout barrier with the key, the swivel barrier can be moved in both directions and locks automatically in the 90° position. The key can be removed before the end position is reached.



Anti-panic feature as standard

The checkout barriers can be opened in both directions with a certain amount of counter-pressure.

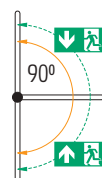

Accessories

Acoustic panic alarm

The acoustic panic alarm notifies the personnel when the anti-panic feature is triggered by an unauthorised person.



90° angle adapter

Base installation in front of the cash desk. 2 adapters are required per swivel barrier of the S checkout barrier.

Finish: high-gloss chrome-plated.

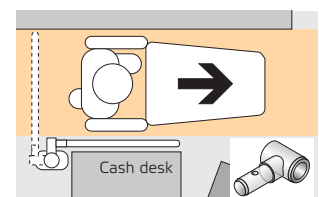

90° angular adapter, 1 unit
Prod.No. 23.08415.10

04.08 S and FS checkout barriers

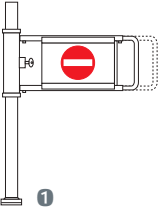
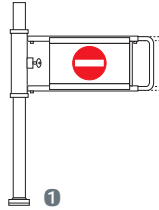
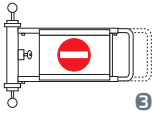
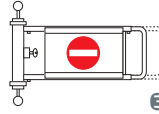
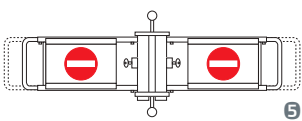
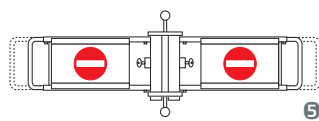
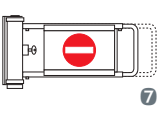
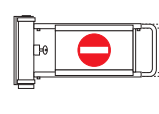
S checkout barrier – standard design		
Extending swivel barrier	from 500 - 750 mm	from 600 - 950 mm
On the base	Opening in both directions	Opening in both directions
Prod.No.	23.02733.10/73*	23.02734.10/73*
Installation with base		
Delivery incl. fixing material		
With tube fixture	Single, opening in both directions	Single, opening in both directions
Prod.No.	23.02737.10/73*	23.02738.10/73*
For installation between connecting tubes of the double-tube Classic customer guidance system		
Delivery incl. fixing material		
With tube fixture	Double, opening in both directions	Double, opening in both directions
Prod.No.	23.02741.10/73*	23.02742.10/73*
For installation between connecting tubes of the double-tube Classic customer guidance system		
Delivery incl. fixing material		
With flange	Opening in both directions	Opening in both directions
Prod.No.	23.02745.10/73*	23.02746.10/73*
For installation on the wall or checkout desk		
Delivery incl. fixing material		

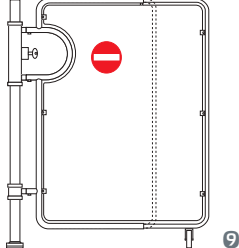
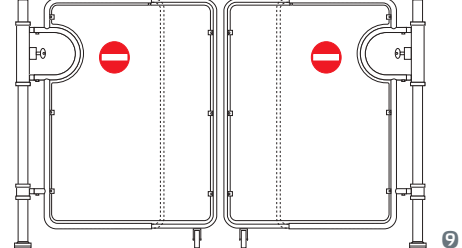
FS checkout barrier		
Width of swivel barrier can be reduced from 1045 - 745 mm		
On the base	Single system	Double system
Height 1400 mm Prod.No.	23.02750.10/73*	23.02751.10/73*
Height 2000 mm Prod.No.	23.02755.10/73*	23.02756.10/73*
Assembly with high base		
Delivery incl. fixing material		

* Example orders: 23.02733.10
23.00110.73

High-gloss chrome-plated
Plastic powder-coated,
colours available upon request

Only as required:
Lock with handle part for S and FS checkout barriers
Key for S and FS checkout barriers

Prod.No. 00.87780.00
Prod.No. 00.53137.22

04.08 S and FS checkout barriers

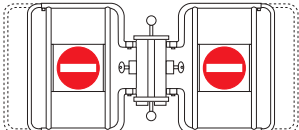
S checkout barrier – high design		
Extending swivel barrier	from 500 - 750 mm	from 600 - 950 mm
On the base	Opening in both directions	Opening in both directions
Prod.No.	23.02735.10/73*	23.02736.10/73*
Installation with base		
Delivery incl. fixing material		
With tube fixture	Single, opening in both directions	Single, opening in both directions
Prod.No.	23.02739.10/73*	23.02740.10/73*
For installation between connecting tubes of the double-tube Classic customer guidance system		
Delivery incl. fixing material		
With tube fixture	Double, opening in both directions	Double, opening in both directions
Prod.No.	23.02743.10/73*	23.02744.10/73*
For installation between connecting tubes of the double-tube Classic customer guidance system		
Delivery incl. fixing material		
With flange	Opening in both directions	Opening in both directions
Prod.No.	23.02747.10/73*	23.02748.10/73*
For installation on the wall or checkout desk		
Delivery incl. fixing material		

Accessories for S and FS checkout barriers	
Acoustic panic alarm	
Prod.No.	98.06668.95
	

S checkout barrier

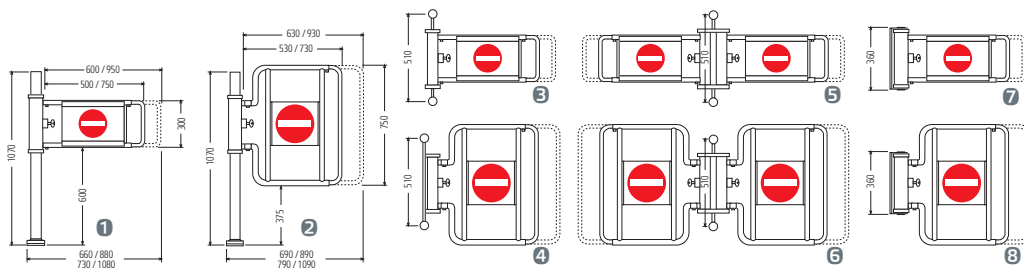

FS checkout barrier

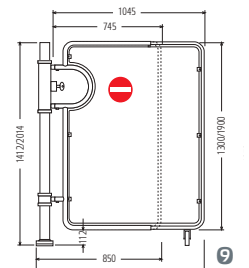

04.09 Security checkout barrier

The especially reliable solution for the checkout zone

- › *Height regulated to prevent climbing*
- › *Difficult to pass goods through*
- › *Door leaf made of acrylic glass*



SECURITY CHECKOUT BARRIER
On the base

04.09 Security checkout barrier

■ The **Security checkout barrier** is a particularly secure design that helps to reduce theft levels. People are prevented from leaving the store through unmanned tills.

Design

Sturdy steel tubing, with integrated lock.
 Door leaf made of transparent, 8 mm-thick acrylic glass, with no entry symbols on both sides. High-gloss chrome-plated or coloured plastic powder-coated finish.

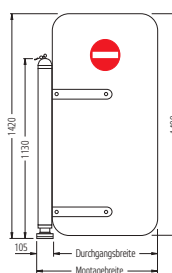

For adaptation in line with the relevant access width, the Security checkout barriers are available in installation widths ranging from 605 to 1055 mm and the corresponding access widths of 500 to 950 mm in 50 mm increments.

Function

Once the checkout barrier has been unlocked, the gate can be swung in either direction and always locks in the 90° position. It is only be unlocked with the key and is self-closing.

Lock

Integrated in the base. The key can be removed before the end position is reached.



Anti-panic feature as standard

The checkout barrier can be opened in the direction of the exit when a certain amount of counter-pressure is applied.

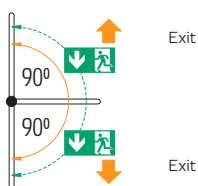

"Lockable" Security checkout barrier			
	Access width mm	Installation width mm	Prod.No.
<p>Emergency exit direction</p> <p>Emergency exit direction</p> <p>Emergency</p> <p>Anti-panic feature as standard</p>	500	605	23.40041.10/73*
	550	655	23.40045.10/73*
	600	705	23.40049.10/73*
	650	755	23.40053.10/73*
	700	805	23.40057.10/73*
	750	855	23.40061.10/73*
	800	905	23.40065.10/73*
	850	955	23.40069.10/73*
	900	1005	23.40073.10/73*
	950	1055	23.40077.10/73*

* Example orders: 23.40041.10 High-gloss chrome-plated
 23.40041.73 Plastic powder-coated,
 Colour and stainless steel design on request.

Only as required:
 Spring lock
 Key

Prod.No. 93.14251.00
 Prod.No. 00.25430.00

04.10 mGate®

Comfort checkout barrier and electronic swing doors

- > Controlled by Checkout Manager PRO, control panel, RFID, LAN, etc.
- > Panic alarm and panic function on both sides as standard
- > Automatic swivel barrier/swivel arm reset



CE Electromagnetic Compatibility (EMC) certification

MGATE® COLOUR
Basic design with base, Colour Classic swivel barrier and sign with illuminated "no entry" symbol

Pat. pend.

Design pend.

Design pend.

MGATE®
Basic design with base, high model swivel barrier and sign with "no entry" symbol

MGATE® COLOUR
Basic design with flange and ESG safety glass Colour swivel arm with illuminated "no entry" symbol (design example available on request)

MGATE®
Basic design with flange, Classic swivel barrier and white sign with "no entry" symbol

04.10 mGate®/mGate® Colour

■ The **mGate® barriers** are the most modern and innovative of their kind. The intelligent control electronics enable reliable operation at all times and allow you to specially adapt the product to your needs. The improved design, new functions and diverse barrier options expand the application range for check-outs etc.

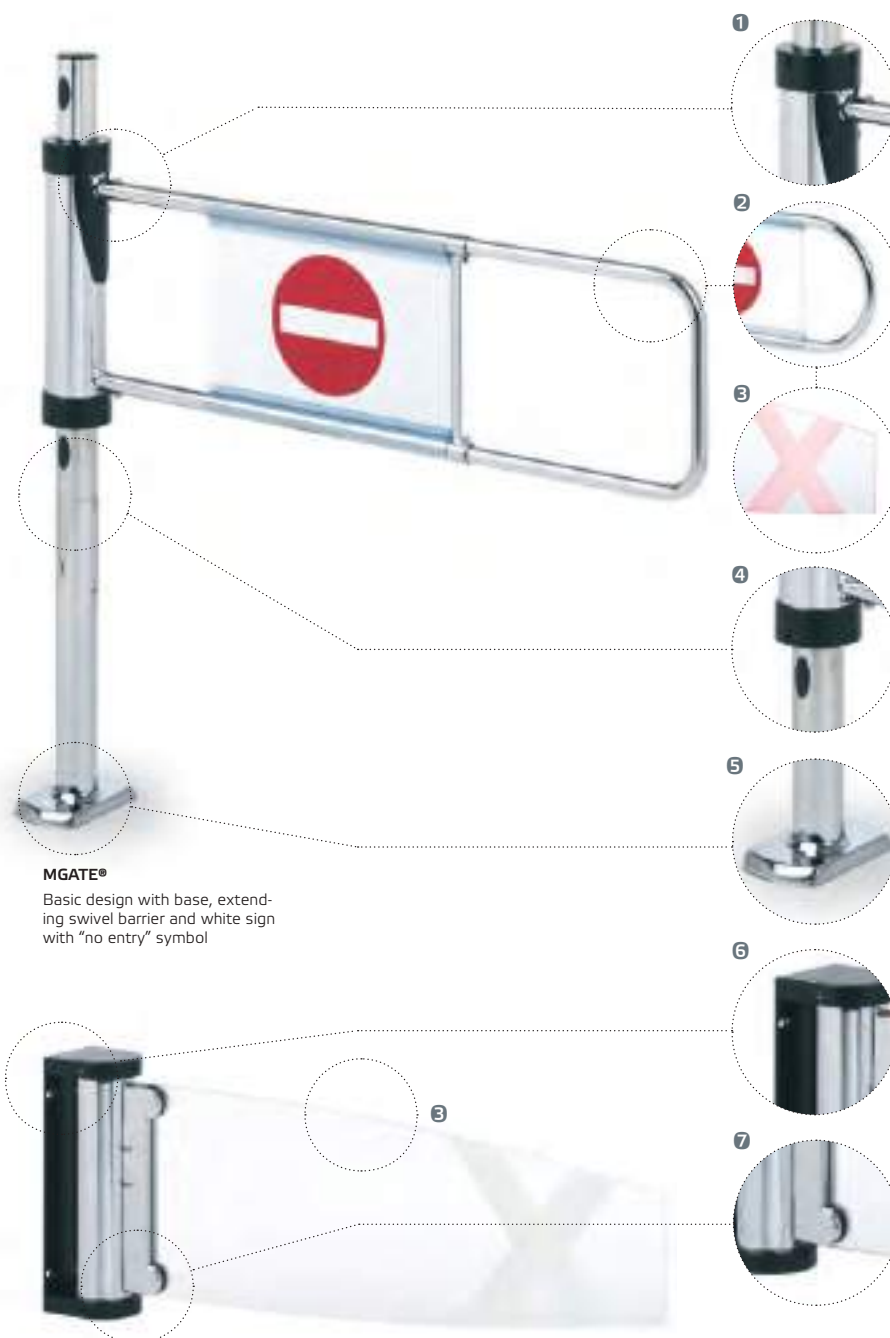

MGATE®

Basic design with base, extending swivel barrier and white sign with "no entry" symbol

MGATE®

Basic design with flange and ESG safety glass swivel arm with "no entry" symbol (design example available on request)

1 SWIVEL COMPONENT

With connecting ports for installing the Classic or Colour Classic swivel barriers

2 SWIVEL BARRIER

With white or transparent sign

- made from sturdy steel tube in three lengths
- made from sturdy steel tube, extendable
- made from sturdy steel tube in high model, extendable

With illuminated sign

- made from sturdy steel tube in three lengths
- made from sturdy steel tube, length-adjustable

SIGN (EXAMPLE)

Illuminated acrylic glass design with "no entry" symbol

3 SWIVEL ARM

Made from shatter-proof ESG safety glass

- for individual lettering
- with "no entry" or "arrow" symbol

Colour made from shatter-proof ESG safety glass

- for individual lettering
- with "no entry" or "arrow" symbol
- visual light guide with LED light strip
- customisable colour options

SWIVEL ARM (EXAMPLE)

ESG safety glass design with "no entry" symbol

4 BASE

Sturdy steel tube Ø 60 mm

Connections for Classic customer guidance system available as standard in 90°, 180° and 270° versions and covered with plastic caps

5 BASE PLATE

Four screw connections

Slots for precise alignment

Base plate cover made from steel plate

6 FLANGE

Sturdy assembly plate with four fixing holes

7 SWIVEL COMPONENT

With holders for ESG safety glass swivel arms or ESG safety glass Colour swivel arms

Please note: mGate and mGate Colour are not entrance systems, exit systems or exit gates. They are only to be used for the information area or as checkout barriers.

04.10 mGate®/mGate® Colour

Reducing inventory differences

When checkouts are not in use, the mGate® ensures that customers can only pass through staffed checkouts. Your staff are immediately alerted to any attempts at manipulation by means of an alarm.



Opening up escape routes

In the event of an emergency, the system opens up the checkout area/exit to provide an escape route. To restore normal operational readiness, the mGate® returns to its original position completely automatically.



Design

Basic design with base: Base with base plate and base plate cover for floor mounting. Casing for swivel mechanism with high-gloss chrome or coloured plastic powder coating. Energy-saving brake system. Fitted with panic alarm and panic function on both sides as standard and connections for attaching the Wanzl Classic customer guidance system.

Basic design with flange: Sturdy assembly plate for installation on cash desks or walls. Casing for swivel mechanism with high-gloss chrome or coloured plastic powder coating. Energy-saving brake system. Fitted with panic alarm and panic function on both sides as standard.

Swivel barriers: Sturdy steel tube with white or transparent plastic sign, available with either “no entry” symbols on both sides or with an “arrow” symbol on the front and a “no entry” symbol on the back.

Colour swivel barrier: Sturdy steel tube with illuminated glass sign with “no entry” symbol visible on both sides.

ESG swivel arm: Shatter-proof ESG safety glass for individual lettering or with “no entry” symbol.

ESG Colour swivel arm: Shatter-proof ESG safety glass for optimal light guidance, for individual lettering or with “no entry” symbol and LED light strip at bottom. LED light colour can be customised.

Basic design with base

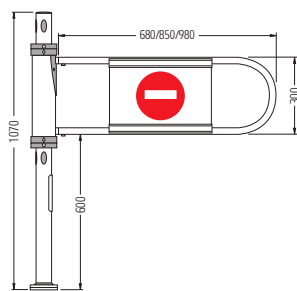
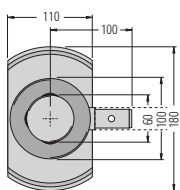

with Classic swivel barrier

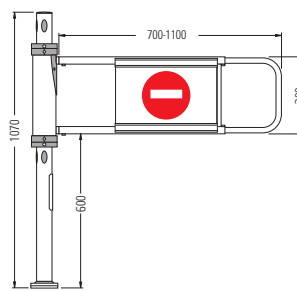

with extending swivel barrier

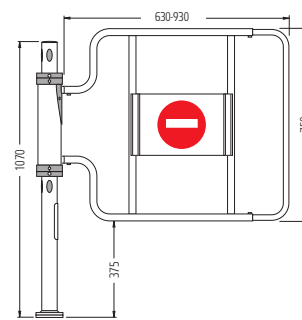

with high model swivel barrier

Basic design with flange

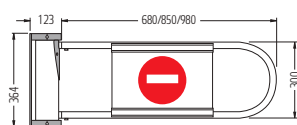
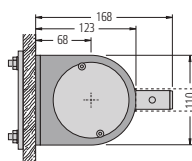

with Classic swivel barrier

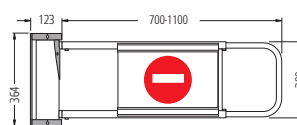

with extending swivel barrier

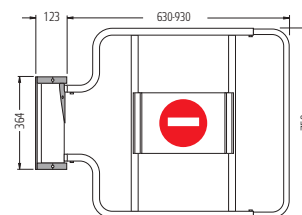

with high model swivel barrier

04.10 Practical exits with attractive through ways

Functions

Adjustable opening angle (0-180°), can be programmed using teach-in. Reliable and precise locking mechanism. Automatic barrier reset and anti-panic feature on both sides.

Control

Controlled by checkout computer, Checkout Manager Pro, RFID, network module WENI control with LAN connection, control panel or button. In combination with Checkout Manager Pro, the mGate® opens and closes automatically when the operator logs in or out of the checkout.

Electronic anti-panic feature

Double-sided with acoustic panic alarm and automatic swivel barrier/ swivel arm reset.

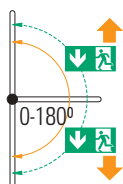

Exit Operating voltage of 24 V for optimum safety; systems therefore comply with national and international safety requirements. Energy-saving thanks to fail-safe brake – the brake fixes the swivel barrier/arm in the latching positions without consuming electricity.

Minimum energy consumption

Accessories

RFID sensor for opening using card or key ring (e.g. time recording). After release, the **Push2Go function** is activated and the barrier is opened by gently pushing it in the required direction of passage.

Control panel, control panel with WENI control or button for manual opening. **Webserver** (software) for control panel with WENI control, can be operated using a web browser on a tablet or smartphone.

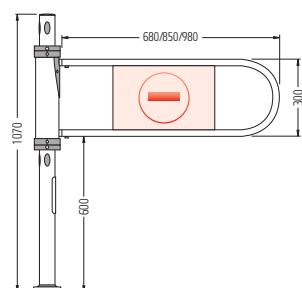

with Colour Classic swivel barrier

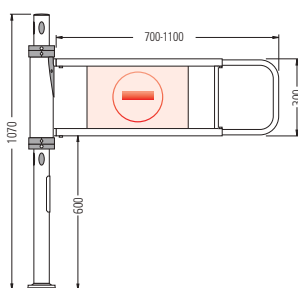

with length-adjustable Colour swivel barrier

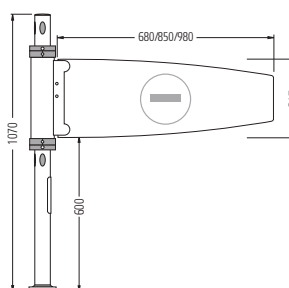

with ESG safety glass swivel arm with "no entry" symbol

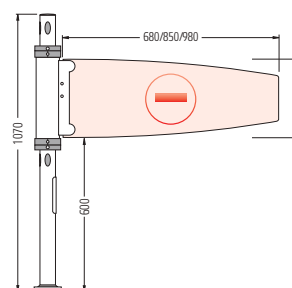

with ESG safety glass Colour swivel arm with "no entry" symbol

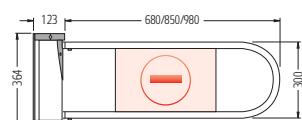

with Colour Classic swivel barrier

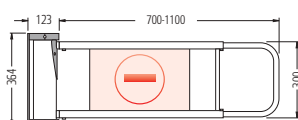

with length-adjustable Colour swivel barrier

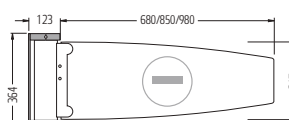

with ESG safety glass swivel arm with "no entry" symbol

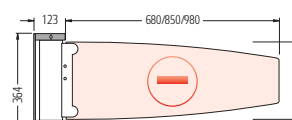

with ESG safety glass Colour swivel arm with "no entry" symbol

04.10 mGate® Checkout/mGate® Checkout Colour

mGate® Checkout		With base		With flange	
Basic design		For swivel barrier		For swivel barrier	
Basic design without swivel barrier, 1 m connecting cable Designs with high-gloss chrome or plastic powder coating		Prod.No.		Prod.No.	
		23.51795.10/73-9005*		23.51790.10/73-9005*	
Colour basic design		For Colour swivel barrier		For Colour swivel barrier	
Colour basic design without swivel barrier, 1 m connecting cable Designs with high-gloss chrome or plastic powder coating		Prod.No.		Prod.No.	
		23.51796.10/73-9005*		23.51791.10/73-9005*	
Basic design		For ESG safety glass swivel arm		For ESG safety glass swivel arm	
Basic design without swivel arm, 1 m connecting cable Designs with high-gloss chrome or plastic powder coating		Prod.No.		Prod.No.	
		23.51797.10/73-9005*		23.51792.10/73-9005*	
Colour basic design		For ESG safety glass Colour swivel arm		For ESG safety glass Colour swivel arm	
Colour basic design without swivel arm, 1 m connecting cable Designs with high-gloss chrome or plastic powder coating		Prod.No.		Prod.No.	
		23.51798.10/73-9005*		23.51793.10/73-9005*	

Accessories: RFID sensor and Push2Go function			
Prod.No.	RFID module for base design	RFID module for flange design	Key
	23.79136.95-0000	23.73128.95-0000	98.76110.00-0000
Releases barrier with card or key ring and opens it in the required direction of passage with a gentle touch			

* Example orders: 23.51795.10-9005 High-gloss chrome-plated,
23.51795.73-9005 Plastic powder-coated,
colours available upon request.

04.10 Perfect system

Swivel barriers/swivel arms

Classic swivel barrier

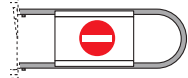

Bar length	Sign with		Sign with	
	White	Transparent	White	Transparent
680 mm	23.38307.10-0005**	23.38307.10-0000**	23.38307.10-0004**	23.38307.10-0003**
850 mm	23.72235.10-0000**	23.38194.10-0000**	23.38194.10-0004**	23.38194.10-0002**
980 mm	23.53583.10-0000**	23.38420.10-0000**	23.38420.10-0004**	23.38420.10-0002**

Extending swivel barrier

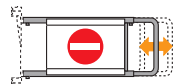

Bar length	Sign with		Sign with	
	White	Transparent	White	Transparent
Height 300 mm, extends from 700 to 1100 mm	00.90271.10-0003**	00.90271.10-0002**	00.90271.10-0000**	00.90271.10-0001**

High model swivel barrier

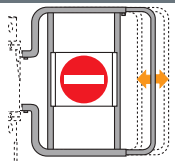

Bar length	Sign with		Sign with	
	White	Transparent	White	Transparent
Height 750 mm, extends from 630 to 930 mm	23.29498.10-0004**	23.29498.10-0002**	23.29498.10-0000**	23.29498.10-0005**

Colour Classic swivel barrier, sign with "no entry" symbol

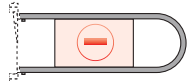

Bar length	Prod.No.
680 mm	23.67949.10-0000**
850 mm	23.65124.10-0000**
980 mm	23.68740.10-0000**

Colour length-adjustable swivel barrier, sign with "no entry" symbol

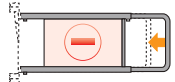

Bar length	Prod.No.
300 mm high, retracts from 1100 to 750 mm	23.65011.10-0000**

ESG safety glass swivel arm for individual lettering

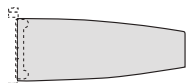

Arm length	In both directions
680 mm	23.62760.00-0000
850 mm	23.62772.00-0000
980 mm	23.62785.00-0000

ESG safety glass swivel arm with "no entry" symbol

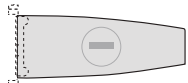

Arm length	In both directions
680 mm	23.64001.00-0002
850 mm	23.64014.00-0002
980 mm	23.64028.00-0002

ESG safety glass Colour swivel arm for individual lettering

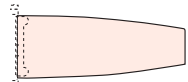

Arm length	In both directions
680 mm	23.62870.00-0000
850 mm	23.62882.00-0000
980 mm	23.62896.00-0000

ESG safety glass Colour swivel arm with "no entry" symbol

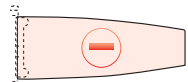

Arm length	In both directions
680 mm	23.64112.00-0002
850 mm	23.64135.00-0002
980 mm	23.64151.00-0002

Accessories: control panels/button

Control panel

Prod.No. 98.76201.00-0000

For manual opening

Order connecting cable separately,
max. 50 m available



Control panel with WENI control

Prod.No. 98.76204.00-0000

With network card***
For manual opening

Order connecting cable separately,
max. 50 m available



Button

Prod.No. 23.79249.95-0000

For manual opening
Feed line 5 m

Connecting cable max. 50 m
available



** Swivel barrier with high-gloss chrome finish.
Swivel barriers with stainless steel or plastic powder coating available on request.

*** Accessories for control panel with WENI control: Webserver 98.76287.00-0000

Connecting cables for control panels:	5 m	98.76206.00-0000
	15 m	98.76207.00-0000
	30 m	98.76335.00-0000
Patch cables:	5 m	98.74362.00-0000
	15 m	98.74364.00-0000

04.11 eGate® Checkout

Convenient checkout barrier with many security functions

- > Automatic opening and closing with log-in and log-out at the checkout
- > Adjustable anti-panic feature, automatic barrier reset
- > Function can be extended by future-proof interfaces

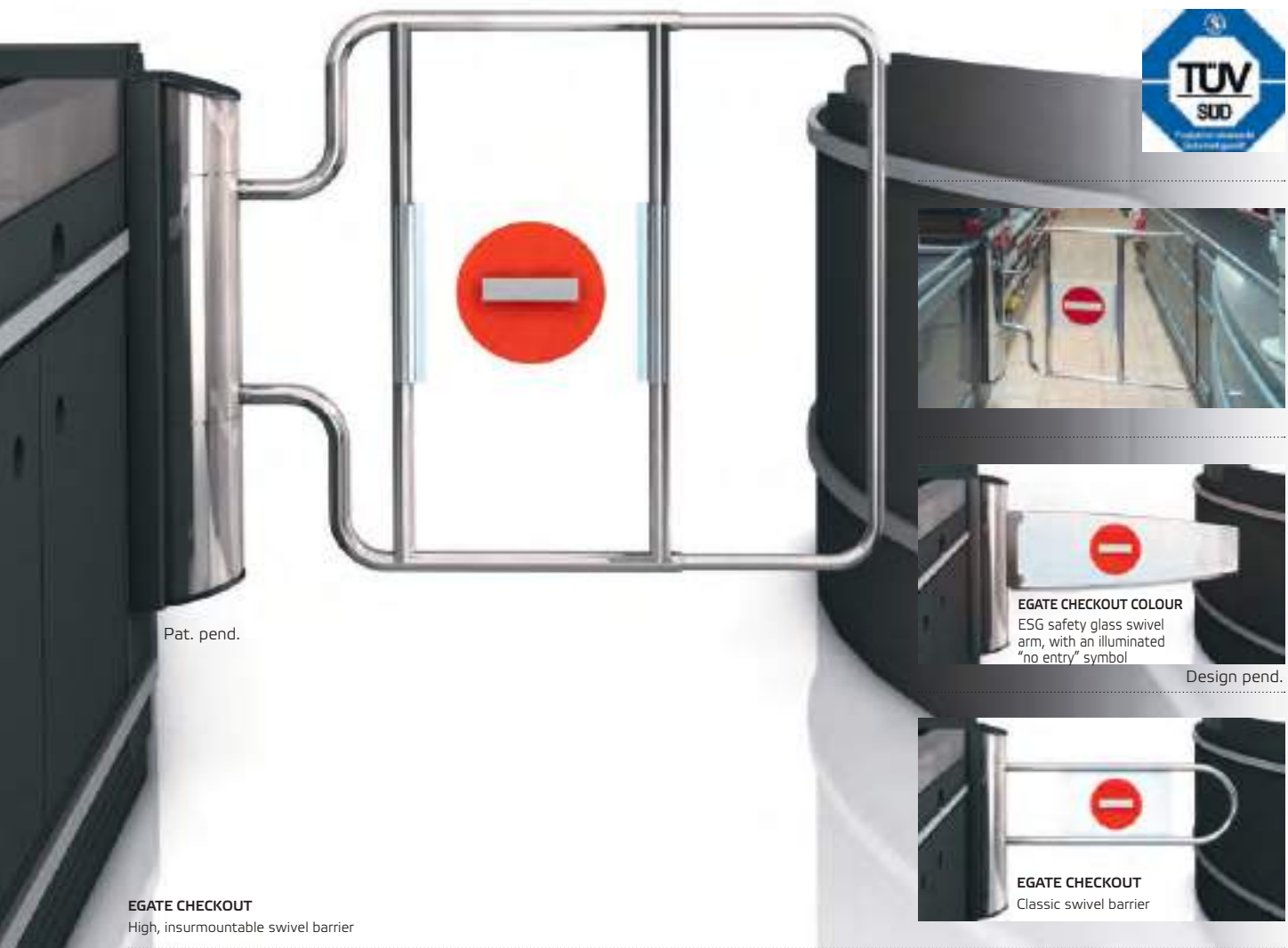

Pat. pend.

EGATE CHECKOUT COLOUR
ESG safety glass swivel arm, with an illuminated "no entry" symbol

Design pend.

EGATE CHECKOUT
High, insurmountable swivel barrier

EGATE CHECKOUT
Classic swivel barrier

04.11 eGate® Checkout

■ The **eGate Checkout checkout barriers** are the most modern and innovative barriers of their type. The intelligent control electronics ensure reliable operation at all times and can be adapted to all requirements.

Reducing inventory differentials

When some checkouts are not in use, eGate® Checkout ensures that customers can only pass through staffed checkouts. Your staff are immediately alerted of any attempts at manipulation by means of an alarm.



Opening up escape routes

In the event of an emergency, the system opens up the checkout area/exit to provide an escape route. To resume normal operations, the eGate® Checkout returns automatically to its original position.



Design

Stable mounting plate for assembly on walls or cash desks, housing for swivel mechanism with high-gloss chrome-plated, coloured plastic powder-coated or stainless steel finish. Energy-saving and adjustable brake system. A variety of swivel barriers and swivel arms.

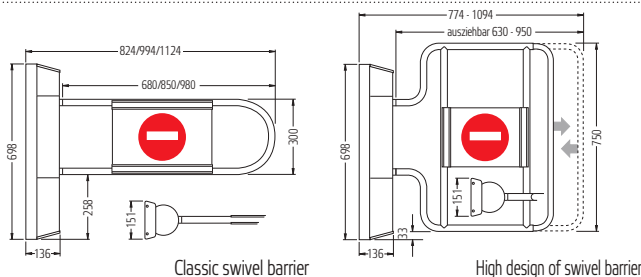

Control

Control via cash-desk PC or Checkout Manager Pro (see page 123), RFID, control panel, etc.

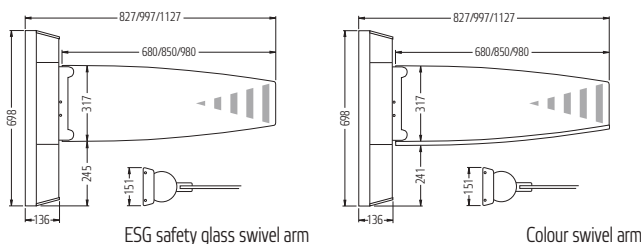

Functions

Adjustable opening angle (0-180°), automatic barrier return, adjustable anti-panic feature.

Electronic anti-panic feature

The adjustable anti-panic feature is adapted to the requirements on site. With acoustic panic alarm.

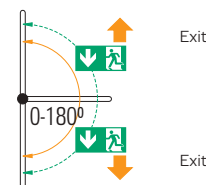





Accessories

RFID sensor for opening using card or key ring (e.g. time recording). After release, the **Push2Go function** is activated and the barrier is opened by gently pushing it in the required direction of passage.

Control panel for manual opening.

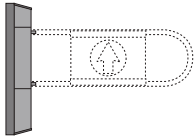
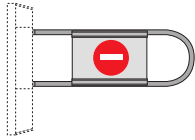
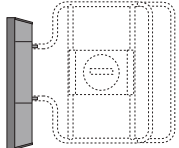
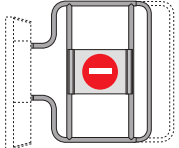
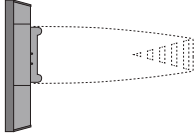
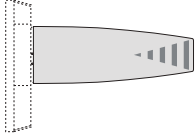
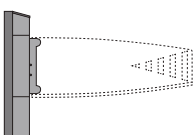
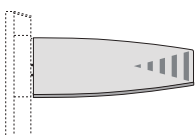

04.11 eGate® Checkout

eGate Checkout					
Classic swivel barrier					
	Prod.No.		Bar length	Prod.No.	
	23.22410.10/09/73-7016*		680 mm	23.38307.10-0003**	
			850 mm	23.38194.10-0002**	
			980 mm	23.38420.10-0002**	
High design of swivel barrier					
	Prod.No.		Bar length	Prod.No.	
	23.22410.10/09/73-7016*		extends from 630 to 930 mm	23.29498.10-0005**	
ESG safety glass swivel arm					
	Prod.No.		Arm length	Opening to the left	Opening to the right
	23.22411.10/09/73-7016*		680 mm	23.68041.00-0001	23.68042.00-0001
			850 mm	23.20582.00-0001	23.20581.00-0001
		980 mm	23.20695.00-0001	23.20696.00-0001	
Colour swivel arm					
	Prod.No.		Arm length	Opening to the left	Opening to the right
	23.22412.10/09/73-7016*		680 mm	23.20037.00-0001	23.20038.00-0001
			850 mm	23.20034.00-0001	23.20034.00-0001
		980 mm	23.20035.00-0001	23.20036.00-0001	
Accessories					
RFID sensor and Push2Go function					
	Prod.No.	RFID module	Key		
		98.76087.95-0000	98.76110.00		
For release with card or key ring, and opening in the required direction of passage with a gentle touch					
Control panel					
	Prod.No.	With 5 m feed line	With 15 m feed line		
		98.76085.00	98.76086.00		
For manual opening					

* Example orders: 23.22410.10 High-gloss chrome-plated
 23.22410.09 Stainless steel
 23.22410.73-7016 Plastic powder coating in anthracite grey
 RAL 7016
 Other colours available on request.

** Swivel barrier with high-gloss chrome finish. Transparent plastic sign with "no entry" symbols on both sides. Swivel barriers with stainless steel or plastic powder coating available on request.

04.12 Checkout Manager PRO

Checkout guidance system for eGate Checkout to satisfy the most stringent requirements

- > Reduces customer waiting times through targeted deployment of staff
- > Future-proof thanks to state-of-the-art technology and interfaces
- > Individual voice prompts – ensuring maximum benefits for customers and staff

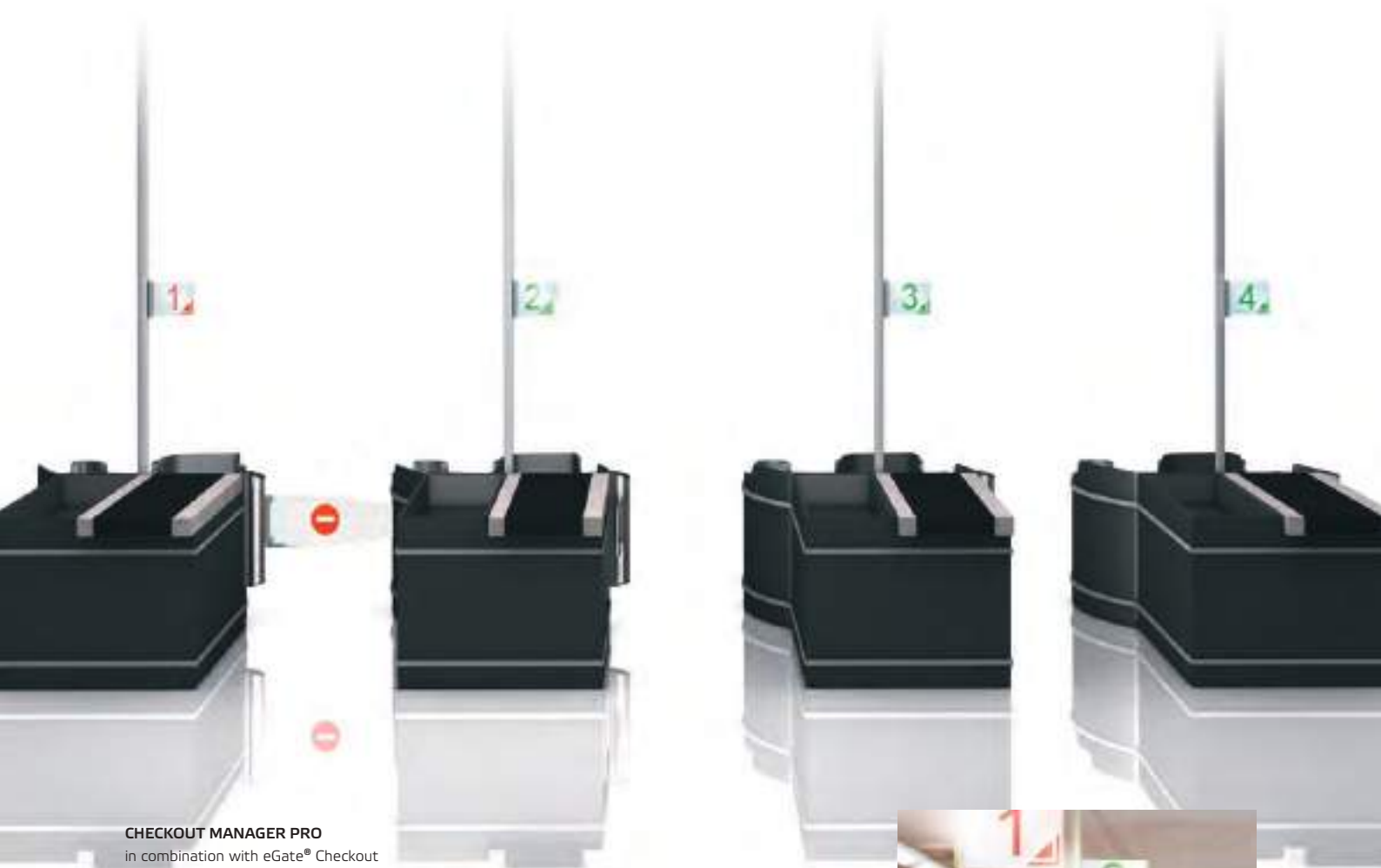

CHECKOUT MANAGER PRO
in combination with eGate® Checkout



04.12 Checkout Manager PRO

■ The **Checkout Manager Pro** enables processes in the checkout area to be coordinated in a reliable manner. Through targeted deployment of staff, checkouts are manned and waiting times for customers are reduced. Individual voice announcements inform the customers about the opening and closing of the tills, and also notify the store managers and staff of where in the store they are required.

The complete solution made by wanzi

Design

Checkout Manager Pro consists of the following basic package per checkout: LED display unit, control using power unit and control panel with housing or for installation in the cash desk.



Checkout Manager PRO with control panel for installation in the cash desk

LED display unit

The **LED display unit is an eye-catching feature** that draws attention to the checkout area and informs your customers whether the checkout in question is available. This helps avoid irritating waiting times.



Design pend.

Future-proof technology

The very latest **control panels** for up to ten checkouts, with housing or for installation in the cash desks. All control elements are easy to use and offer individual installation options. Checkout Manager Pro is ideally equipped for future tasks.



Accessories

The **LCD unit notifies the store manager** of the current status (max. 6 checkouts).



The **LED unit informs staff or the store manager** of where they are required in very noisy environments, e.g. in the warehouse.



Thanks to **various extension sets**, the system easily adapts to the size of the existing store.



Touch-PC with CMP-PC-APP. Intuitive user interface with the checkout status for up to 10 checkouts on display for store management. Opportunity to play back information and advertisements.



04.12 Checkout Manager PRO

Operational examples

Control panel for controlling up to 10 checkouts.



Volume control

The volume control for the various store areas takes place directly on the checkout 1 control panel.

Explanation of symbols/assignment of keys

Keys for checkouts 1-10



Store Manager key

"Set main checkout" key

Break key

Checkout barrier key

Request and opening of a further checkout

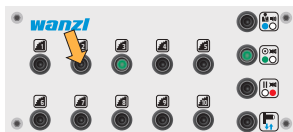

Press the key for **checkout 2** if it is to be opened

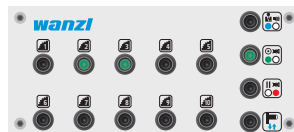

The LEDs for the checkout 2 and 3 keys glow green on all checkouts



The LED display on checkout 2 flashes green
Voice announcement: checkout 2 is being opened for you
The LED display on checkout 2 glows green
Repeat of the voice announcement after 60 seconds if no log-in has taken place at the checkout

Checkout occupancy takes place by log-in at checkout 2
eGate Checkout for checkout 2 opens
The LED display unit at checkout 2 glows green

Opening a further checkout

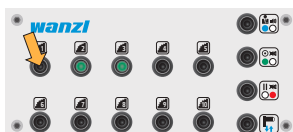

Logging on to checkout 1

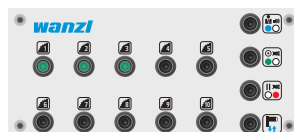

The LEDs for the checkout 1, 2 and 3 keys glow green on all checkouts



The LED display at checkout 1 flashes green for the duration of the voice announcement: checkout 1 is being opened for you

eGate Checkout opens
The LED display unit at checkout 1 glows green

Closing a checkout

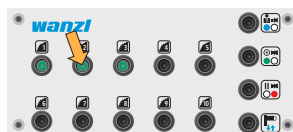

Press the key for **checkout 2** when it is to be closed

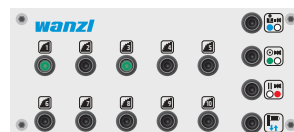

The LEDs on the key for checkout 2 go out on all checkouts



The LED display on checkout 2 flashes red
Voice announcement: this checkout is closing...
The LED display on checkout 2 glows red
Repeat of the voice announcement after 60 seconds if no log-off has taken place at the checkout

Checkout log-offs take place at checkout 2
eGate Checkout for checkout 2 closes
The LED display unit at checkout 2 goes out

04.12 Checkout Manager PRO

Request branch manager

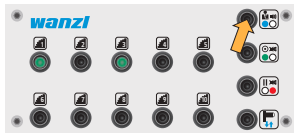

Press the **branch manager** key on logged-in checkout 1

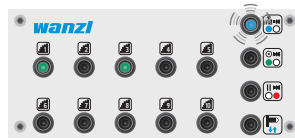

The LEDs on the checkout 1 and 3 keys glow green on all checkouts
The LED on the branch manager key flashes blue



The LED display at checkout 1 flashes blue/green for 60 seconds
Voice announcement: Branch manager to checkout...
The LED display at checkout 1 glows green after 60 seconds

Cancel request



Press the **branch manager** key again on logged-in checkout 1
The LED display switches to green
The branch manager key on checkout 1 goes out

Opening the main checkout

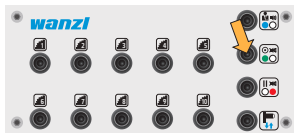

Press **Set main checkout** key
Logging on to checkout 3

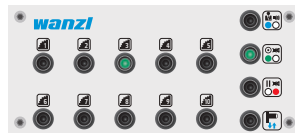

The LEDs of the keys for the main checkout and checkout 3 glow green on checkout that has been set as checkout 3



eGate Checkout for checkout 3 opens
No voice announcement
The LED display unit at checkout 3 always glows green

Initiate break

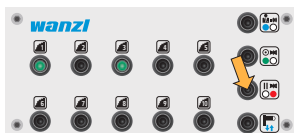

Press the **Break** key on logged-in checkout 1

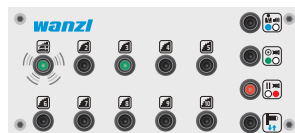

The LEDs on the checkout 1 key flash green at all checkouts
During the break, it is not possible to select checkout 1 from any other checkout











The LED display at checkout 1 immediately switches to red
No voice announcement

End break



Press the **Break** key again on checkout 1
The LED display on checkout 1 remains red
It is possible to log in again

04.12 Checkout Manager PRO

Checkout Manager PRO				
Basic package for	3 checkouts	4 checkouts	5 checkouts	6 checkouts
control panel with housing	23.65241.95-0000	23.65242.95-0000	23.65243.95-0000	23.65244.95-0000
control panel for installation in the cash desk	23.65241.95-0001	23.65242.95-0001	23.65243.95-0001	23.65244.95-0001
Basic package for	7 checkouts	8 checkouts	9 checkouts	10 checkouts
control panel with housing	23.65245.95-0000	23.65246.95-0000	23.65247.95-0000	23.65248.95-0000
control panel for installation in the cash desk	23.65245.95-0001	23.65246.95-0001	23.65247.95-0001	23.65248.95-0001
Basic package consisting of: - Control unit - Control panel with housing or control panel for installation in the cash desk - Power unit - Holder for acrylic glass sign - Set of ceiling loudspeakers containing 4 loudspeakers - Set of ceiling loudspeakers containing 2 loudspeakers - All connecting lines				
Acrylic glass sign	Design I - left		Design I - right	
No. 1	97.30170.07-0001		97.30180.07-0001	
No. 2	97.30170.07-0002		97.30180.07-0002	
No. 3	97.30170.07-0003		97.30180.07-0003	
No. 4	97.30170.07-0004		97.30180.07-0004	
No. 5	97.30170.07-0005		97.30180.07-0005	
No. 6	97.30170.07-0006		97.30180.07-0006	
No. 7	97.30170.07-0007		97.30180.07-0007	
No. 8	97.30170.07-0008		97.30180.07-0008	
No. 9	97.30170.07-0009		97.30180.07-0009	
No. 10	97.30170.07-0010		97.30180.07-0010	
Printed checkout number sign, 297 x 200 x 6 mm, fits holder for acrylic glass sign				
Accessories				
	Complete LCD unit	Blue/green LED unit	Touch-PC with CMP-PC-APP	
Prod. No.	23.98457.95	23.98454.95	On request	
Consists of: - Loudspeaker with - LCD display (up to a max. of 6 checkouts) for store manager or common room or - LEDs for warehouse, side rooms, delivery area - Power unit				
Ceiling loudspeaker set	Set 1 with 1 loudspeaker	Set 2 with 2 loudspeakers	Set 3 with 4 loudspeakers	
Prod. No.	23.98455.95	23.98456.95	23.98458.95	
Extension set consisting of: - 1, 2 or 4 ceiling loudspeakers - Power unit - Control unit				

05 Product overview

05.01 ExitGate



01 EGATE SYSTEM



01 TECHNOPORT SYSTEM

05 ExitGates



05.01 ExitGate

For the modern way of paying – self-checkout

- › *Controlled exit from the store after payment*
- › *Available in three different versions: as eGate Colour, eGate or Technoport*
- › *Additional functions, such as customer frequency measurements are possible*



DOUBLE SYSTEM

Promotion swivel barrier, opening in both directions



05.01 ExitGate

■ **ExitGates.** The intelligent ExitGates from Wanzl are an important component of automated checkout systems. They control the flow of customers in a customer-friendly way and prevent inventory differentials.

Computer-based control

Modern microprocessor hardware combined with special software controls the processes in a reliable manner. The components are installed, individually coordinated with one another and adapted to the software precisely as the situation in the store requires.

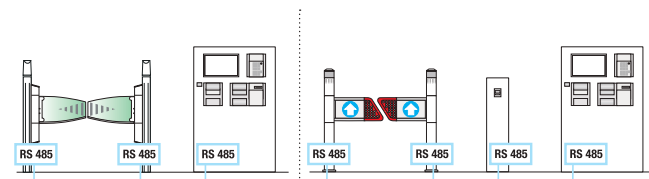

The ExitGates are connected and controlled via a LAN connection or the RS 485 standard computer interface

Customer-friendly

Using the integrated sensor, the ExitGate detects the current situation (slow or fast-moving people, customers with children, etc.). The barriers remain open as long as necessary, but not one second more – for great customer friendliness with maximum security

Flexible software

Wanzl ExitGates are adapted to the requirements of the checkout processes by means of the software. Subsequent changes and adjustments are also possible thanks to an update function integrated in the software.

Anti-panic feature as standard

In an emergency, the integrated anti-panic function allows the barriers to be opened towards the exit both manually and automatically (e.g. via a signal from the building control system). Additionally, on request, individual voice announcements or alarm signals are possible.

Automatic and secure

The automatic barrier return prevents inventory differentials. After the barrier has been opened manually, the ExitGate immediately restores the “operation situation”. Staff are not required to reset the barriers, unlike traditional systems.

Design

eGate Colour system: Aluminium upright, coloured plastic powder-coated finish*. Housing for Classic pivot mechanism available in high-gloss chrome-plated, coloured plastic powder-coated* or stainless steel finish. Swivel arm made of single-plate safety glass, with coloured lighting.

sign made of white plastic or transparent acrylic glass, double-sided.

eGate system: Aluminium upright, coloured plastic powder-coated finish*. Housing for pivot mechanism and Classic swivel barrier with high-gloss chrome plating, coloured plastic powder-coated finish* or in stainless steel. Info

Technoport system: Upright and Classic swivel barrier made of steel tubing, high-gloss chrome-plated or coloured plastic powder coating*. Pivot mechanism made of metal, fully integrated in the upright – provides a particularly high level of injury protection. Sign made of plastic, white or transparent acrylic glass, printed on both sides.

* Colours available on request

05.01 ExitGate

Function - system examples

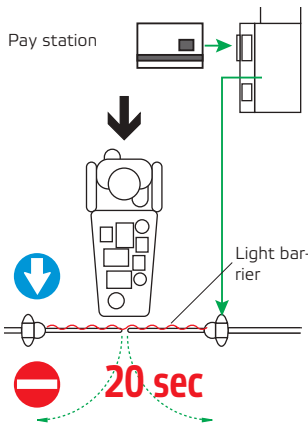

Opening with pre-set time

- The customer pays for the goods at the payment machine
- The payment machine sends an opening pulse to the Exit-Gate
- The ExitGate opens for a pre-set time (e.g. 20 seconds)
- Once the customer has passed through the light barrier, the ExitGate closes after a pre-set time (e.g. 2 seconds)

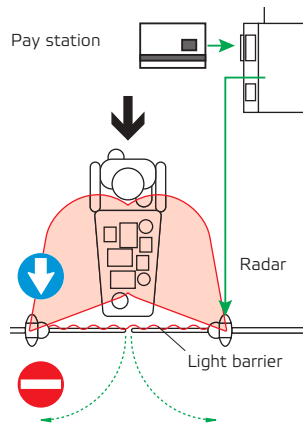

Opening by radar

- The customer pays for the goods at the payment machine
 - The payment machine sends an opening pulse to the Exit-Gate
 - The ExitGate opens when the customer is detected by the radar, for a pre-set time (e.g. 20 seconds)
 - Once the customer has passed through the light barrier, the ExitGate closes after a pre-set time (e.g. 2 seconds)
- With the eGate Colour ExitGate system, the swivel arms glow red. After payment, the lighting switches to green. The swivel arms open if the customer is detected by the radar.

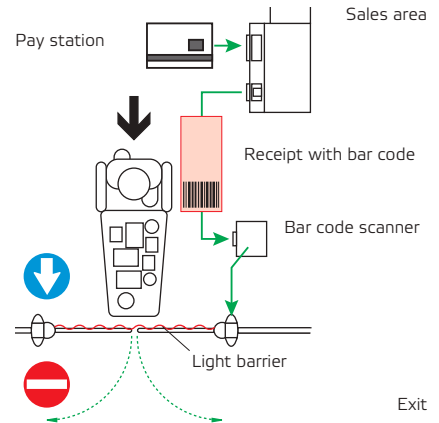

Opening with a bar code

- The customer pays for the goods at the payment machine
- The payment machine issues a receipt with a bar code
- The ExitGate opens after scanning the bar code on the receipt reader for a pre-set time

Standard technical equipment

- Max. operating voltage of 24 V DC for the highest levels of safety.
- eGate systems comply with both national and international safety requirements.
- Even opening of swivel barriers. No swing back. Best positioning globally.
- Synchronised opening of the swivel barrier in all double systems without a central divider.
- Infinitely variable opening angle from 0° - 180°. Precise adjustment using the teach-in procedure.

- Freely programmable opening time, the system then closes again automatically.
- Once the customer has passed through the light barrier, the Exit-Gate closes after the pre-set time (e.g. 2 seconds).
- Direction of opening can be adjusted on-site.
- RS485 interface: Data exchange and remote control via PC.

Individual swivel arms



eGate Colour system

eGate Colour

eGate



Glass
See page 18



Classic
On request



Promotion
On request



Glass
See page 22

Technoport





Classic
On request

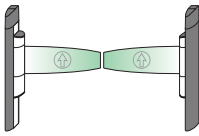
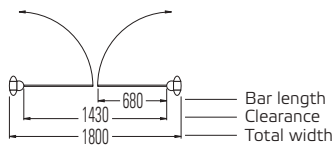
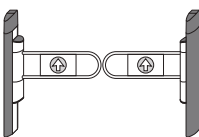
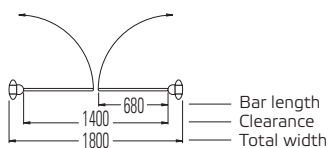
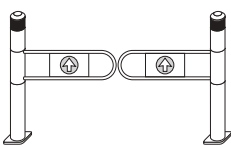
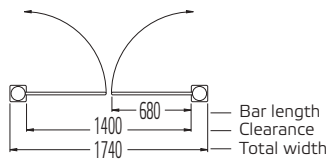

Promotion
On request

05.01 ExitGate

ExitGate		eGate Colour system		
		Opening in both directions		
For ESG safety glass swivel arm Prod.No.		23.73599.10-7016		
2 eGate uprights - without swivel arms (see page 132 for swivel arms)				
ExitGate		eGate system		
		Opening in both directions		
For swivel barrier Prod.No.		23.20818.10-0001		
For ESG safety glass swivel arm Prod.No.		23.73825.10-7016		
2 eGate uprights - without swivel barriers and swivel arms (see page 132 for swivel barriers and arms)				
ExitGate		Technoport system		
		Opening in both directions		
For swivel barrier Prod.No.		23.79907.01-0000		
2 Technoport uprights - without swivel barriers (see page 132 for swivel barriers)				

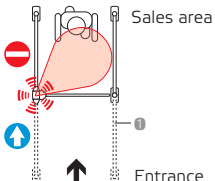
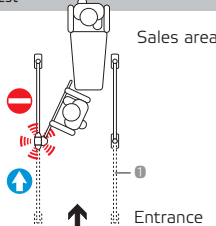
Control panel with counter		Radio remote control	
Prod.No.		Prod.No.	
98.72914.00		98.73693.00	
<p>Passage release for one person using a button, set to permanently open with switch and passage of staff in the opposite direction using a button.</p> 		<p>Remote control of one or more systems. Release in the direction of passage, exit direction or set to permanently open.</p> 	
Exit alarm		Barrier manipulation alarm	
		Prod.No.	
		On request	
<p>For eGate Prod.No.</p> <p>For Technoport Prod.No.</p> <p>The direction-sensing radar triggers an acoustic alarm or a voice announcement.</p>		<p>If the barrier is deliberately manipulated during the closing process, this triggers an acoustic alarm.</p>	
<p>Acoustic</p> <p>77.73594.95</p> <p>77.72117.10</p>		<p>With voice output</p> <p>77.73707.95</p> <p>77.81473.10</p>	
 <p>Sales area</p> <p>Entrance</p>		 <p>Sales area</p> <p>Entrance</p>	

Additional accessories

Exit alarm (siren or voice output), barrier manipulation alarm, swivel range monitoring, Tandem radar, power supply from the ceiling, customer frequency measurement.

06 Product overview

06.01 WCC customer counter



01 SOFTWARE TO DETERMINE
CUSTOMER MOVEMENTS

06.02 Length of stay measurement



02 SOFTWARE TO EVALUATE CUSTOMER
BEHAVIOUR

06.03 Customer frequency measurement with 2D-cam



03 CUSTOMER FREQUENCY
MEASUREMENT WITH 2D-CAMERA

06.04 Customer frequency measurement with direction-sensing radar



04 CUSTOMER FREQUENCY MEASUREMENT WITH
RADAR-CONTROLLED ENTRANCE SYSTEMS

06.05 Customer frequency measurement with light barrier



05 CUSTOMER FREQUENCY MEASUREMENT WITH
LIGHT BARRIER BETWEEN THE BASES

06.06 Customer counting



06 CUSTOMER COUNTING WITH LIGHT
BARRIER BETWEEN THE BASES

06 Customer counting



06.01 WCC customer counter

Optimising processes and deployment of staff

- > *Effective staff deployment planning for more customer satisfaction*
- > *Accurate information on the conversion rate*
- > *Reliable check on success of advertising, to benefit new measures*

■ **Software for determining the customer frequency** in the store and evaluating the data on a PC. The result permits targeted personnel management and act as a basis for statistical evaluations.

Collect information

Personnel management with targeted checkout occupancy, control of staff deployment at serving counters, customer frequency measurement for controlling evaluations, benchmarking of different locations. Check on success of temporary marketing measures.

Application

Evaluation of data using conventional software (e.g. Microsoft Excel). Staff control at checkouts, counters etc.; control of heating and air-conditioning system. Data transfer via the internet.

Minimum PC requirements

Pentium 4, 2.0 GHz or higher, 1 GB RAM, 2 GB available memory, screen resolution of 1024 x 768 or greater, Windows Vista (SP1 required) or Windows 7 (compatible with 32 bit or 64 bit), available network connection (RJ-45 socket), Microsoft .NET Framework v4.0 (necessary system software).

We also recommend Internet Explorer (IE) 6 or above with Java™-Runtime (from V6) installed.

System requirements for entrance systems

Current Wanzl eGate Colour, eGate and Technoport. Older systems can be upgraded.

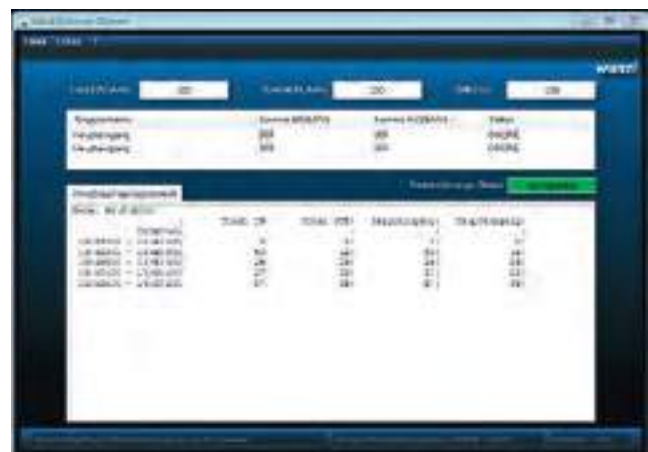

CUSTOMER COUNTER

Clear and detailed overview on the PC

Function

Counting of customers who enter the store at a specific time. Evaluation of individual counting points so as to analyse different areas of the store. Grouping together of counting points to measure customer frequency.

06.02 Length of stay calculation

Provides valuable information for a wide range of benefits

- › *Frequency of persons for controlling evaluations*
- › *Benchmarking of different stores*
- › *Check on success of temporary marketing measures*

■ **Software to determine the length of time** customers spend in the store, based on the data on the PC from the Wanzl Customer Counter. A valuable tool for checking the success of advertising measures, assessing the market and controlling.

Process information in detail

Personnel management with targeted checkout occupancy, control of staff deployment at serving counters, customer frequency measurement for controlling evaluations, benchmarking of different locations. Check on success of temporary marketing measures.

Application

Evaluation of data using conventional software (e.g. Microsoft Excel). Staff control at checkouts, counters etc.; control of heating and air-conditioning system. Data transfer via the internet.

Minimum PC requirements

Pentium 4, 2.0 GHz or higher, 1 GB RAM, 2 GB available memory, screen resolution of 1024 x 768 or greater, Windows Vista (SP1 required) or Windows 7 (compatible with 32 bit or 64 bit), available network connection (RJ-45 socket), Microsoft .NET Framework v4.0 (necessary system software).

We also recommend Internet Explorer (IE) 6 or above with Java™-Runtime (from V6) installed.



CALCULATION OF LENGTH OF STAY

Example: graphical representation of length of stay by week days on the PC

Function

The data for the calculation of length of stay are used to evaluate the average time that your customers spend shopping in the store. These data are used to control the checkout staffing and to optimise routes.

All entrances and exits must be monitored for the calculation of length of stay.

06.03 Customer frequency measurement

Reliable and precise detection with 2D-cam

- > *Stereoscopic camera with precise 2D detection and high count accuracy*
- > *Compact design for high degree of flexibility regarding installation*
- > *Versatile application possibilities*



CUSTOMER FREQUENCY MEASUREMENT

Reliable counting at entrances and exits with stereoscopic camera

STEREOSCOPIC CAMERA

Two-dimensional detection for reliable counting at entrances and exits



06.03 Customer frequency measurement with 2D-cam

■ **Video-based customer frequency measurement** with the very highest counting accuracy provides precise data for staff deployment planning, marketing planning, etc. For added security, these data optimise the energy, building and environmental management systems.

Design

Stereo camera with 2D technology in a compact die-cast aluminium housing that is resistant to vandalism, for ceiling installation.

The very greatest precision

Count accuracy 98%, even under unfavourable conditions, with 2D technology through detection of the height profile. Large detection area of 110°. Detailed evaluation of the data with the WCC Customer Counter and calculation of length of stay.

Technical specifications



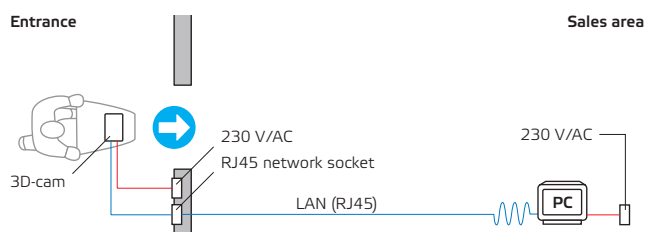

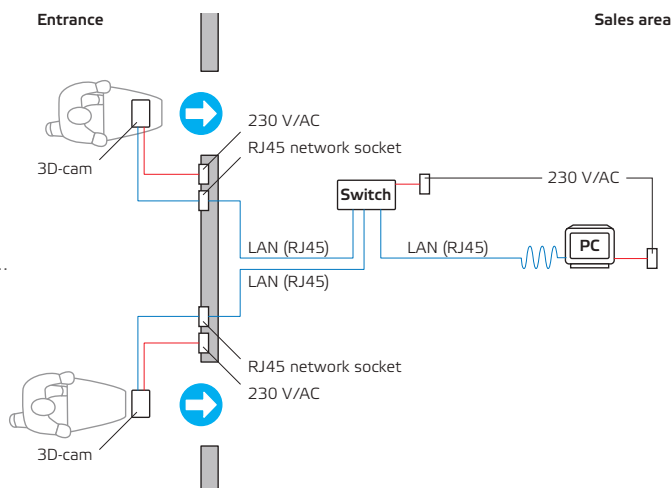

Operating voltage 24 V DC, power consumption approx. 4 W, installation height 2.10 to 4.00 m, detection zone 0.80 to 3.50 m. 1 Ethernet interface.
The light intensity should be at least 100 lux.



CUSTOMER COUNTER diagram with one counting point



CUSTOMER COUNTER diagram with several counting points

Customer frequency measurement with 2D-cam		
Features	1 counting point	Several counting points
Hardware package (per counting point) 2D-camera with ceiling bracket, power unit, M12-RJ45 adapter cable 5 m, 2-pole cable plug, cable for network supply	23.88 058.95-9016 	23.88 058.95-9016 
Software		
WCC basic licence	98.74901.00	98.74901.00
For one or the first counting point		
WCC extended licence	-	98.74902.00
For each further counting point		
Calculation of length of stay	98.74903.00	98.74903.00
Software for installation on a PC		

06.04 Customer frequency measurement

For entrance systems with direction-sensing radar

- > Detection with direction-sensor radar
- > Transfer of the opening/counting pulses to the PC
- > Software for data analysis



■ Reliable detection of **customer frequency** with existing entrance system. Transfer to and evaluation on the PC.

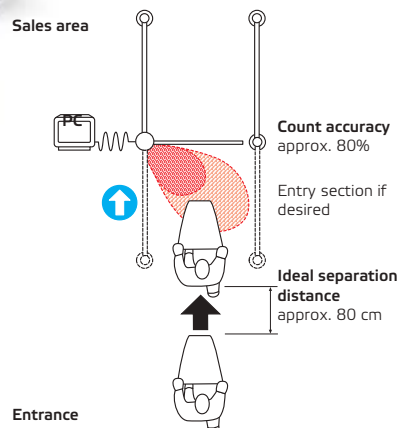

Design

The direction-sensing radar with integrated counting function sends the data to the PC. In double systems, the intelligent electronics reduce miscounts to a minimum.

Function

The opening pulse when entering the radar beam is simultaneously the counting pulse for the PC. Detailed evaluation of the data with the WCC Customer Counter and calculation of length of stay.

Customer frequency measurement for entrance systems

Prod.No.	23.30998.95	
WCC hardware package for RS485 interface Consists of: Plug Interface converter		
Software	1 counting point	Several counting points
WCC basic licence	98.74901.00	98.74901.00
For one or the first counting point	☐	☐
WCC extended licence	-	98.74902.00
For every other counting point		☐
Calculation of length of stay	98.74903.00	98.74903.00
For installation on a PC	☐	☐

Data lines: 5 metres Prod.No. 98.73689.00, 25 metres Prod.No. 98.73690.00, 50 metres Prod.No. 98.73691.00, 100 metres Prod.No. 98.73720.00

06.05 Customer frequency measurement

With light barrier between the bases

- > Reliable information for many evaluations
- > Transfer of the counting pulses to the PC
- > Software for data analysis

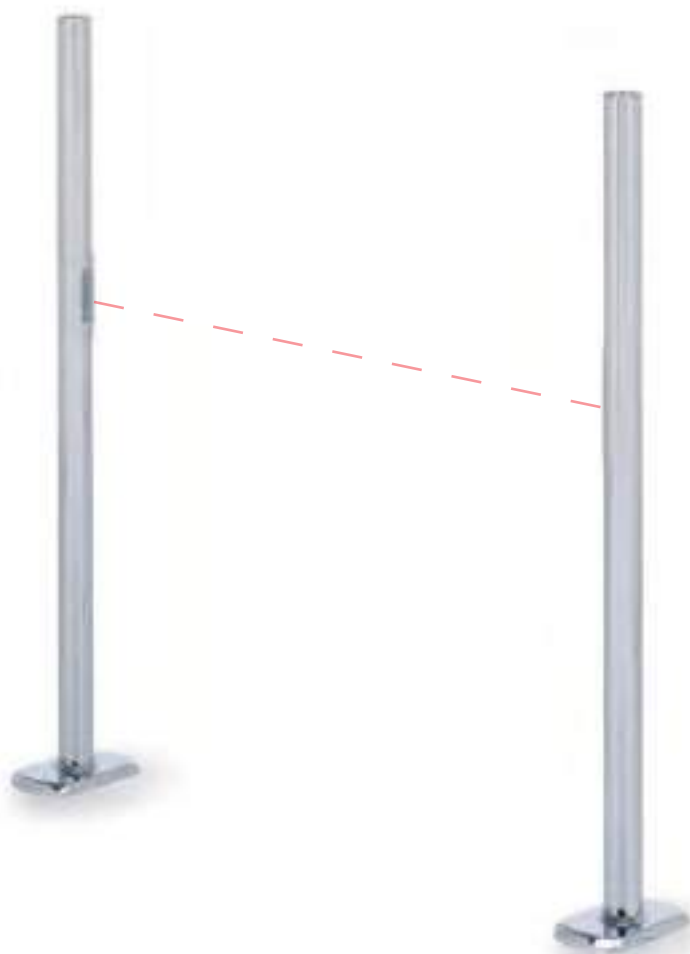

■ Reliable **customer frequency measurement** for determination of the customer and visitor numbers and comprehensive evaluation on the PC.

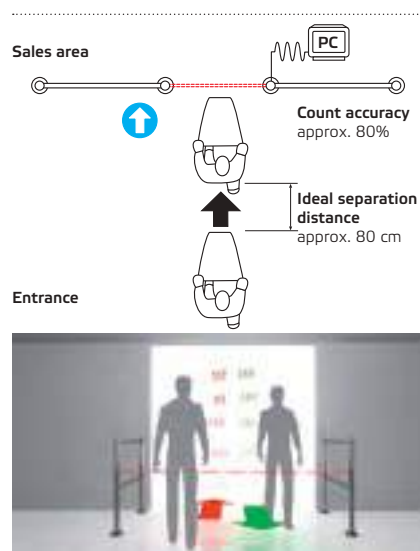

Design

Bases made of steel tubing, high-gloss chrome-plated or with coloured plastic powder coating*. Direction-sensing infrared barrier, max. access width 1.5 m.

Function

Counting pulse when someone passes through the light barrier, and transmission to the PC. Detailed evaluation of the data with the WCC Customer Counter and calculation of length of stay.

Customer frequency measurement – fixed system		
	Basic unit	Extended part
Prod.No.	23.43654.10/73*	23.43655.10/73*
1 base with 50 mm diameter, with light barrier 1 base with 50 mm diameter, with reflecting mirror Incl. installation fittings See below for data lines and hardware package		
	max. 1610	max. 1610
	max. 1500	max. 1500
	Ø 50	Ø 50
	Ø 50	Ø 50
Software	1 counting point	Several counting points
WCC basic licence	98.74901.00	98.74901.00
For one or the first counting point		
WCC extended licence	-	98.74902.00
For every other counting point		
Calculation of length of stay	98.74903.00	98.74903.00
For installation on a PC		

Data lines: 5 metres Prod.No. 98.73689.00, 25 metres Prod.No. 98.73690.00, 50 metres Prod.No. 98.73691.00, 100 metres Prod.No. 98.73720.00. Hardware package Prod.No. 23.30998.95

* Example orders: 23.43654.10
23.43654.73

High-gloss chrome-plated
Plastic powder coating, please
specify the colour required.

06.06 Customer counting

With light barrier between the bases

- > Simple counting of customers and visitors
- > Transfer of the counter to a digital counter in the base
- > Suitable for areas or passages with low traffic

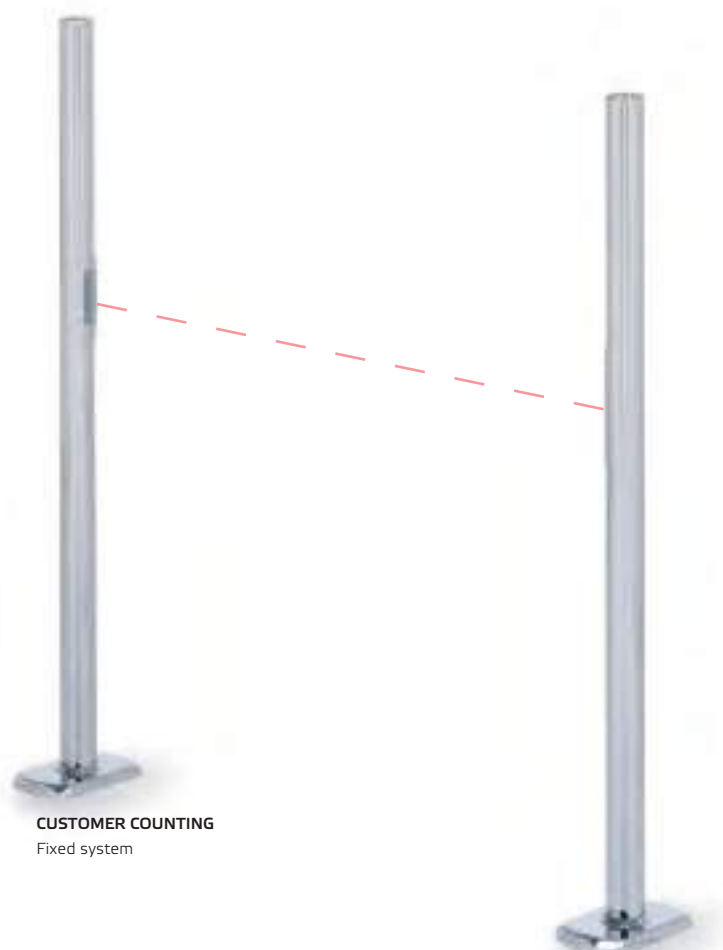

CUSTOMER COUNTING
Fixed system

■ Reliable **customer counting** to determine the numbers of customers and visitors during a specific time period.

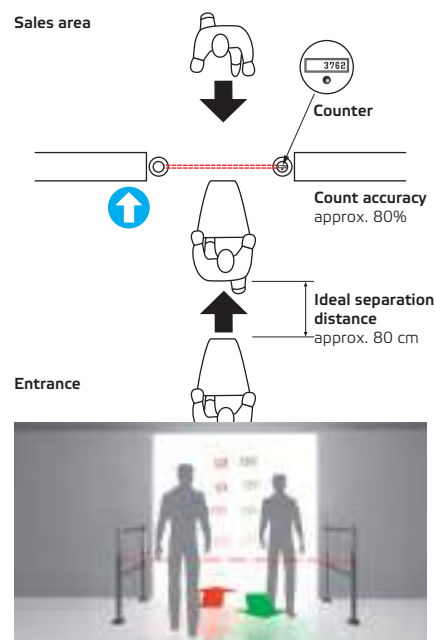

Design

Bases made from steel tubing with rectangular base plate covers, high-gloss chrome-plated finish or coloured plastic powder coating*. Direction-sensing light barrier, max. access width 1.5 m, digital counter.

Function

Counting pulse when someone passes through the light barrier. Persons entering are counted. Counter can be reset manually.



Customer counting

Fixed system

Prod.No.

23.84416.10/73*

1 base with a diameter of 50 mm with light barrier
1 base with a diameter of 50 mm with reflecting mirror
Incl. installation fittings

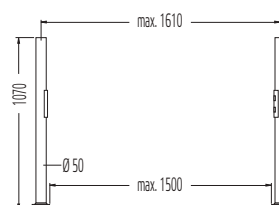

* Example orders: 23.84416.10
23.84416.73

High-gloss chrome-plated
Plastic powder coating, please specify the colour required.

WENI-Control network module

With LAN connection for control independent of the operating system

- > For entrance systems using the WEAC control system
- > Suitable for eGate Colour, eGate, Technoport, ExitGate
- > System control via PC, tablet PC or smartphone

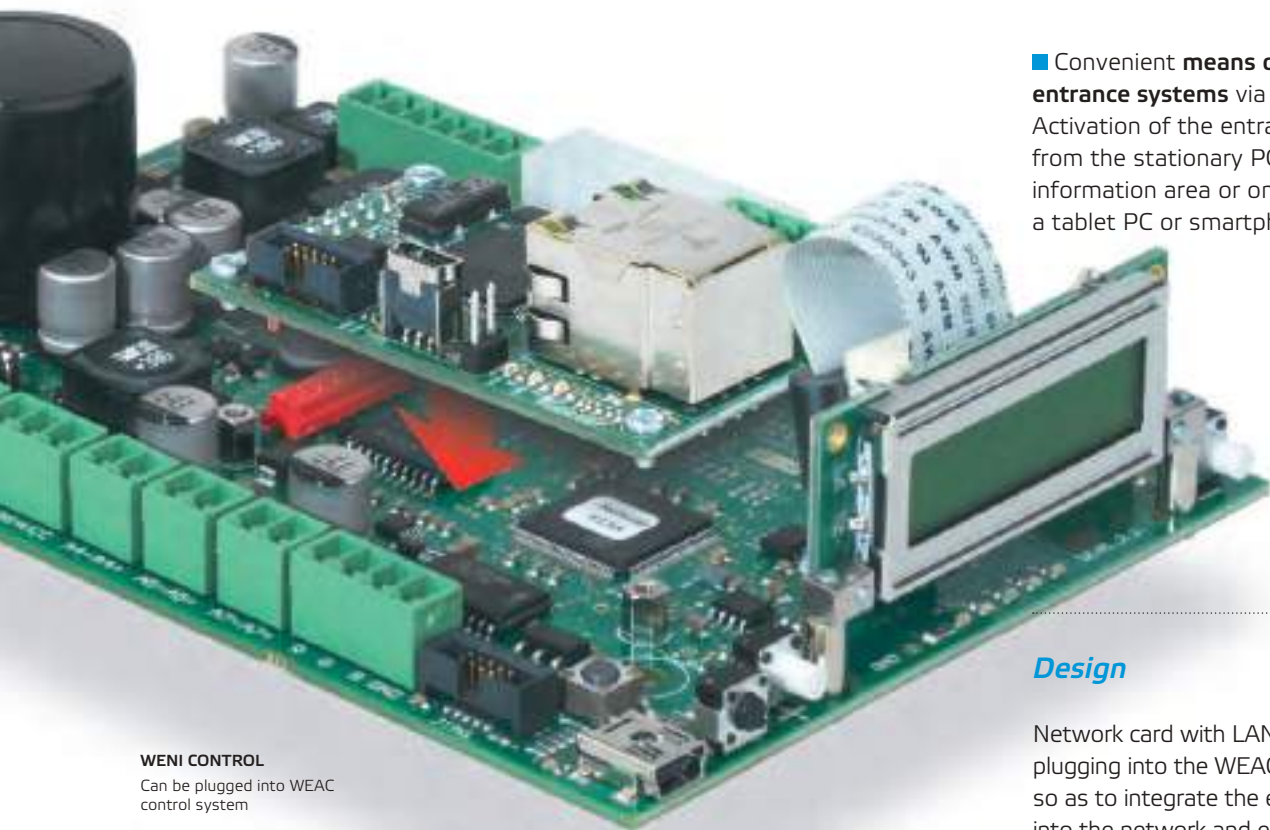

■ Convenient **means of controlling entrance systems** via a network. Activation of the entrance system from the stationary PC, e.g. in the information area or on the move with a tablet PC or smartphone.

WENI CONTROL
Can be plugged into WEAC control system

Design

Network card with LAN connection for plugging into the WEAC control system, so as to integrate the entrance systems into the network and enable control via PC, tablet PC and smartphone.

Function

Individual release, permanently open in the opposite direction, display of the number of panic and exit alarms.



Further functions

Control of an external bar code reader.
Web server optimised for remote control with smartphones and tablets (touch interface).
Connection of an external camera for monitoring the passages (gates).

WENI control

Network module

Prod.No. 98.76287.00-0000

Network card for plugging into WEAC 2 control circuit board



07 Product overview

07.01 Electrical installation



01 EGATE COLOUR/EGATE

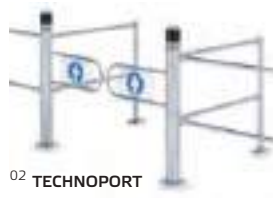

02 TECHNOPORT

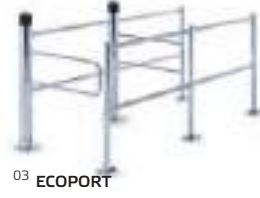

03 ECOPORT



04 CHECKOUT MANAGER PRO

07.05 Accessories



05 SWIVEL RANGE MONITORING



06 INDIVIDUAL COMPONENTS



07 FIXING MATERIAL



08 SPECIAL BASE PLATES

07 Service

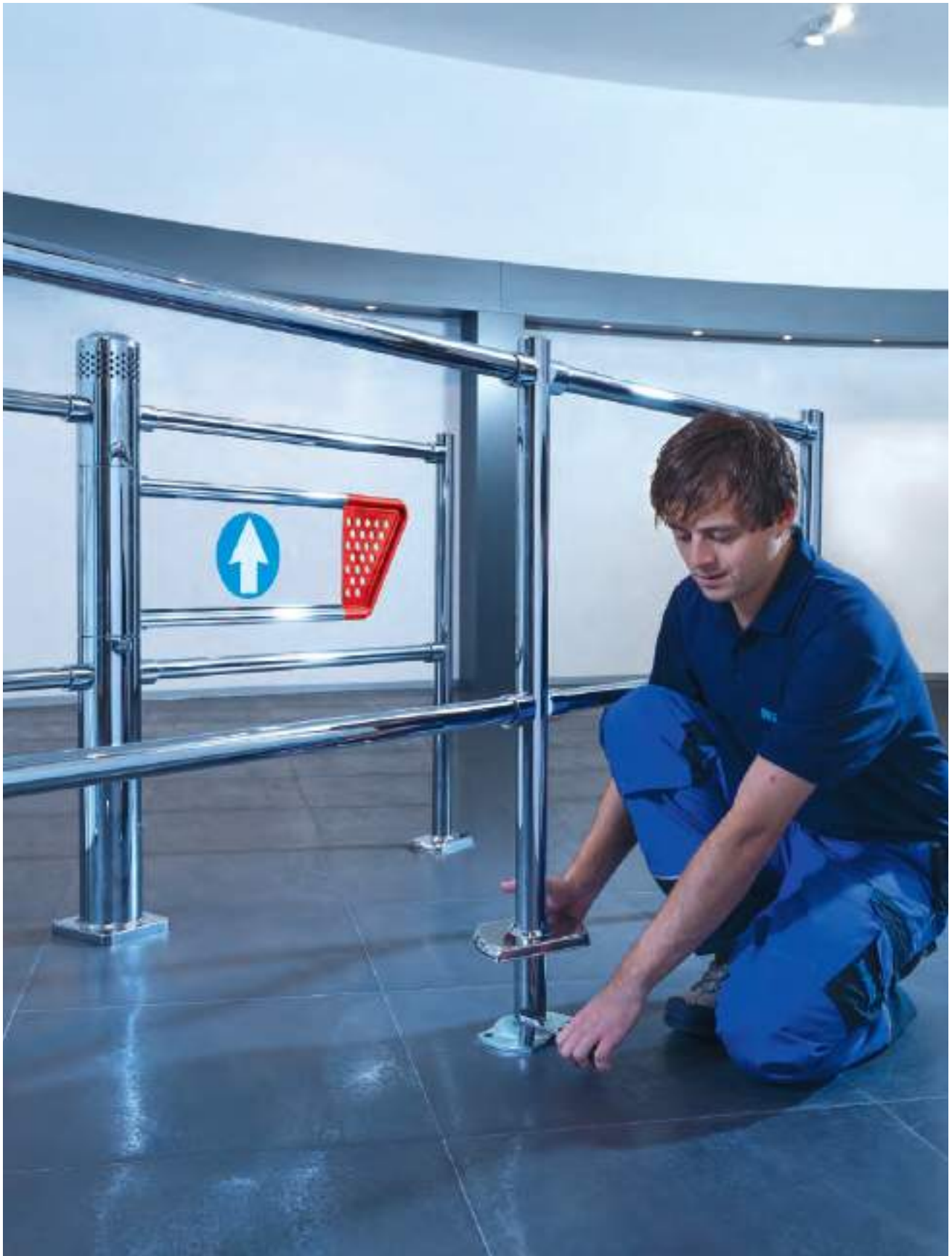

07.01 Electrical installation

Laying the empty conduits for the electrical installation on site

- › *For time-and cost-saving installation of the entrance system*
- › *To prevent damage during installation*
- › *Avoids unnecessary demolition work, particularly with new structures*



07.01 eGate® Colour, eGate®, ExitGates system eGate®

■ **Planning with Wanzl.** The timely involvement of Wanzl in the planning process for new systems and conversion measures makes it possible to safely connect entrance systems through empty conduits in the floor. This is the shortest and most reliable path when controlling double or double-gate systems.

Design

eGate uprights are installed using adhesive anchors. To do this, threaded rods are glued into the load-bearing floor. Once the connecting cables have been fed into the upright, the upright is mounted on the adhesive anchor and secured with screw nuts.



Assembly of entry/exit section with M10x60 hexagonal screws and M10 dowels

Laying electrical installation conduits with power supply from floor

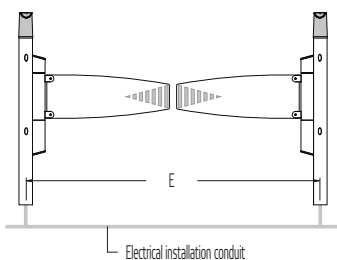
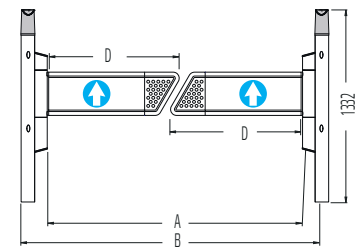
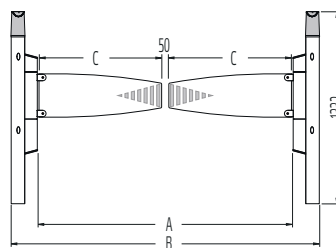
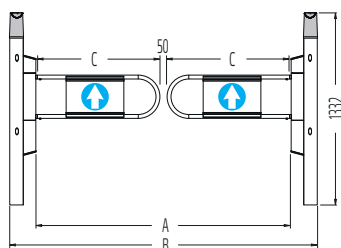
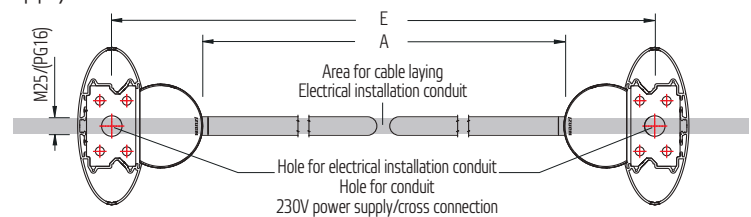
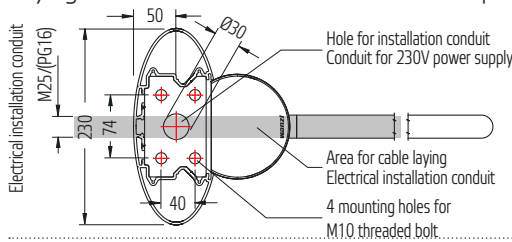

Installation dimensions for eGate entrance systems				
A	B	C	D	E
Access width	Outside measurement	Length Swivel barrier ESG safety glass swivel arm	Length Promotion barrier	Axis dimension Electrical installation conduit
1430 mm	1800 mm	680 mm	735 mm	1695 mm
1770 mm	2140 mm	850 mm	905 mm	2035 mm
2030 mm	2400 mm	980 mm	1035 mm	2295 mm

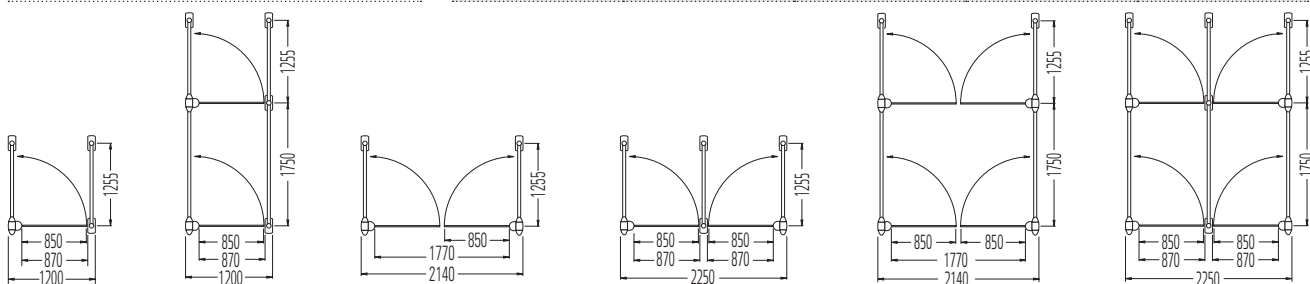

07.02 Technoport®/Technoport® ExitGates

■ **Installation with Wanzl.** Entrance systems connected through an empty conduit in the floor can be installed especially quickly, economically and safely. Make use of our service engineers' experience and skills and ensure that you retain full warranty cover – something that is self-evident for Wanzl.

Design

The connection cables are routed into the Technoport upright from below. The upright is then secured with screws to the dowels that have been positioned in the load-bearing floor. The base plate covers the fixing.



DOUBLE SYSTEM, DOUBLE-GATE, WITH CENTRAL DIVIDER
Classic swivel barrier, opening to the left or right

Laying electrical installation conduits with power supply from floor

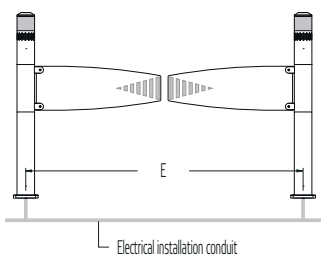
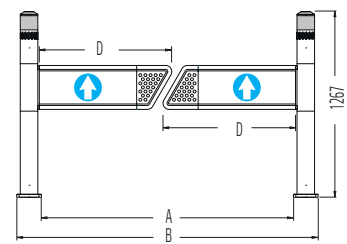
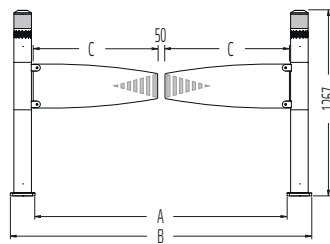
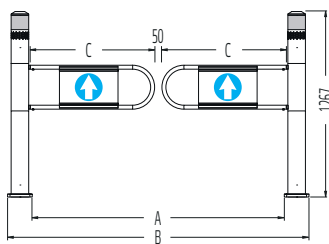
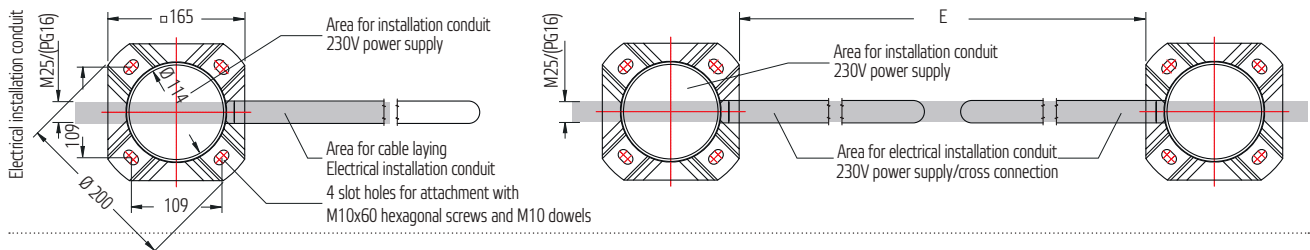

Installation dimensions for Technoport entrance systems				
A	B	C	D	E
Access width	Outside measurement	Length Swivel barrier	Length Promotion barrier	Axis dimension Electrical installation conduit
1400 mm	1740 mm	680 mm	735 mm	1570 mm
1740 mm	2080 mm	850 mm	905 mm	1910 mm
2000 mm	2340 mm	980 mm	1035 mm	2170 mm

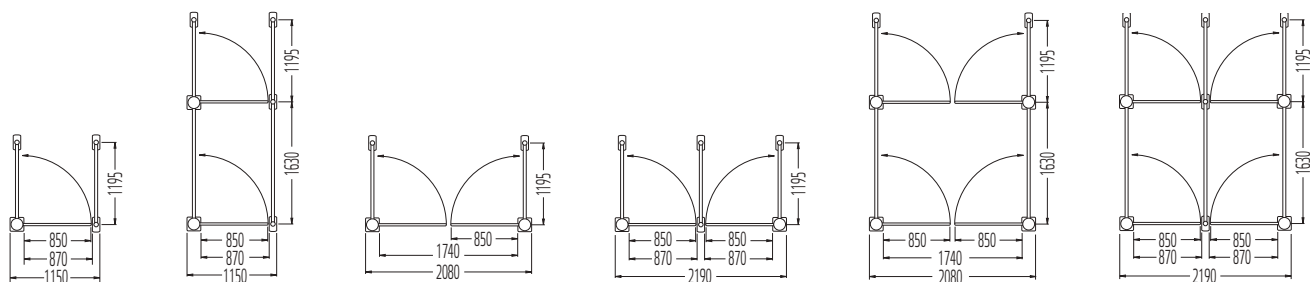

07.03 Ecoport

■ **Service from Wanzl.** Entrance systems that are connected through an empty conduit in the floor are easy to maintain. In the case of necessary, regular services or any repair work that may be required, our service engineers are able to respond rapidly and restore operational readiness.

Design

The connection cables are routed into the Ecoport upright from below. The upright is then secured with screws to the dowels that have been positioned in the load-bearing floor. The base plate covers the fixing.



SINGLE SYSTEM, DOUBLE-GATE WITH ENTRY SECTION
Classic swivel barrier, with sign, opening to the left

Laying electrical installation conduits with power supply from floor

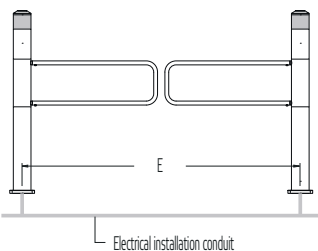
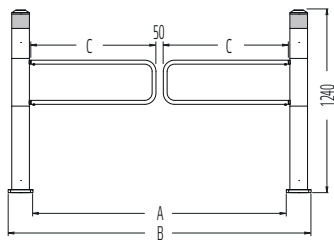
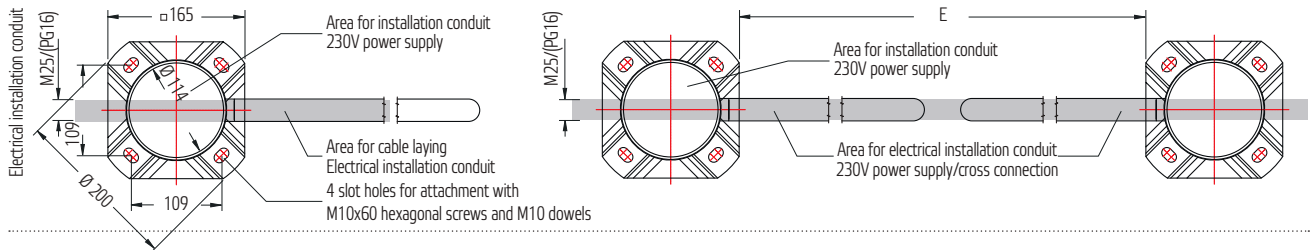

Installation dimensions for Ecoport entrance systems			
A	B	C	E
Access width	Outside measurement	Length Swivel barrier	Axis dimension Electrical installation conduit
1400 mm	1737 mm	680 mm	1570 mm
1740 mm	2077 mm	850 mm	1910 mm
2000 mm	2337 mm	980 mm	2170 mm

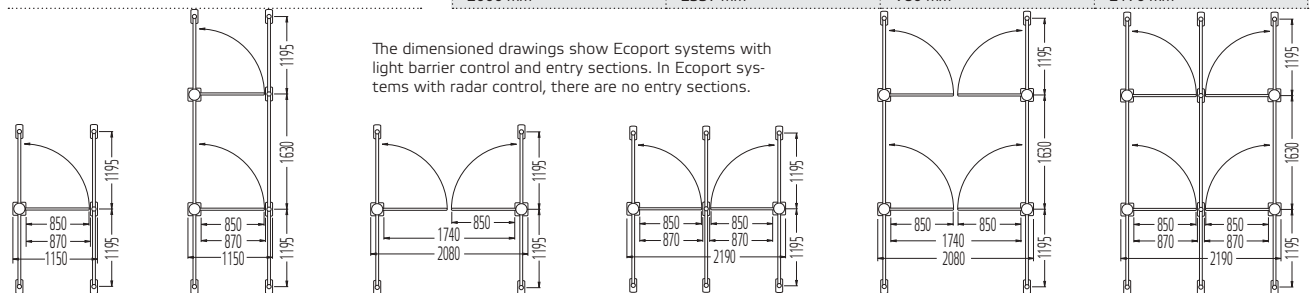

07.04 Checkout Manager PRO layout overview

Systematic application and all-round correct positioning. The Checkout Manager PRO system is particularly impressive when all the components are able to reliably interact together. Employee information is an essential part of the system – it guarantees timely occupation and opening of checkouts as well as customer information relating to which checkouts are available.

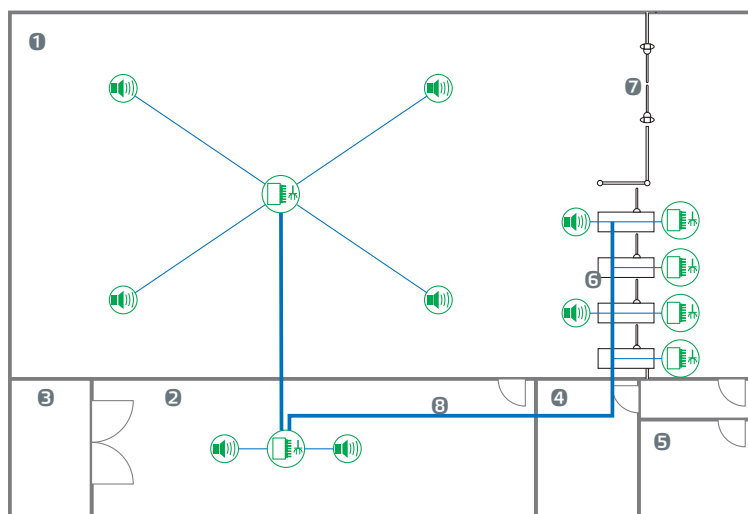

Basic design: basic package

The Checkout Manager PRO is available in a variety of basic packages. These include the necessary components for the checkout and basic equipment for installation in the store and warehouse area.

Example: Basic package with four checkouts.

- 1 Store
- 2 Warehouse
- 3 Ramp
- 4 Office
- 5 Staff room
- 6 Checkout area
- 7 Entrance system
- 8 Bus line
- Control unit
- Loudspeaker

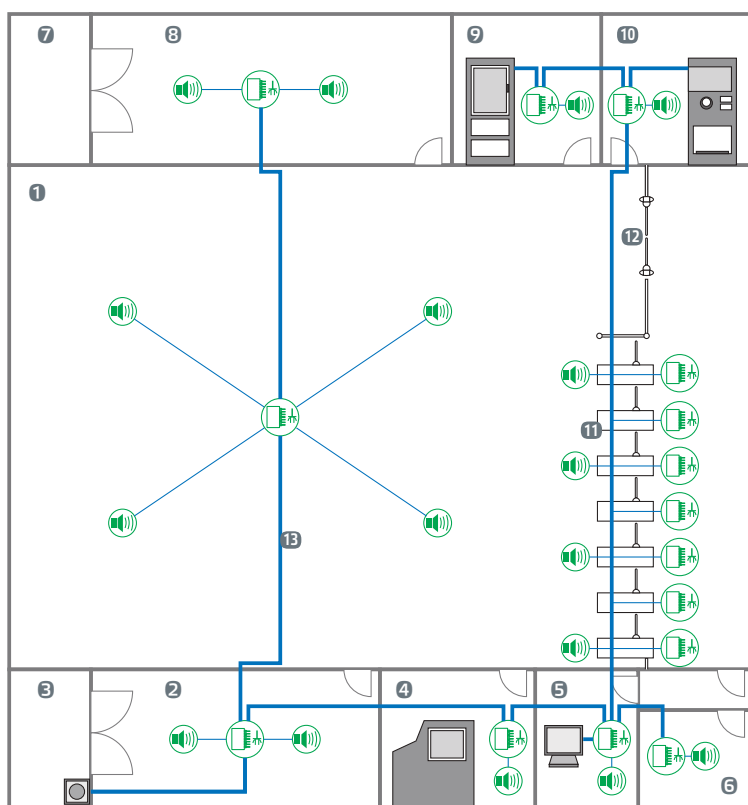

Expansion level: basic package and optional accessories

With the basic package of the standard equipment there is the option of adapting to the exact format of your store using further accessories.

- 1 Store
- 2 Warehouse 1
- 3 Ramp 1
- 4 Cardboard press
- 5 Office
- 6 Staff room
- 7 Ramp 2
- 8 Warehouse 2
- 9 Baking area
- 10 Deposit return
- 11 Checkout area
- 12 Entrance system
- 13 Bus line
- Control unit
- Loudspeaker
- Staff assist call

07.04 Checkout Manager PRO power layout

■ Extremely **simple installation preparation**. Only standard sockets are required on-site.
 Wanzl will take care of installing and laying out the system for you.

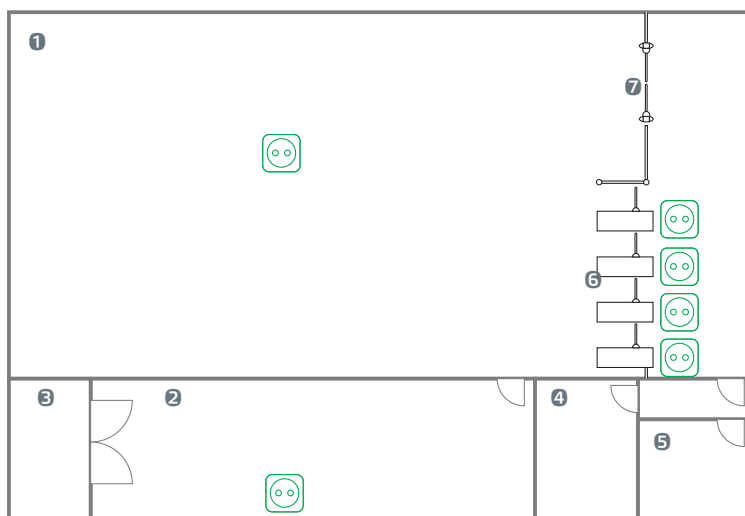

Power supply

For a smooth installation of the Checkout Manager Pro, the required voltage supply is needed at the respective installation points.

Recommendation: A separate electric circuit with time control and night time shutdown is an advantage.

Example: Basic package with four checkouts.

- 1 Store
- 2 Warehouse
- 3 Ramp
- 4 Office
- 5 Staff room
- 6 Checkout area
- 7 Entrance system
- Socket

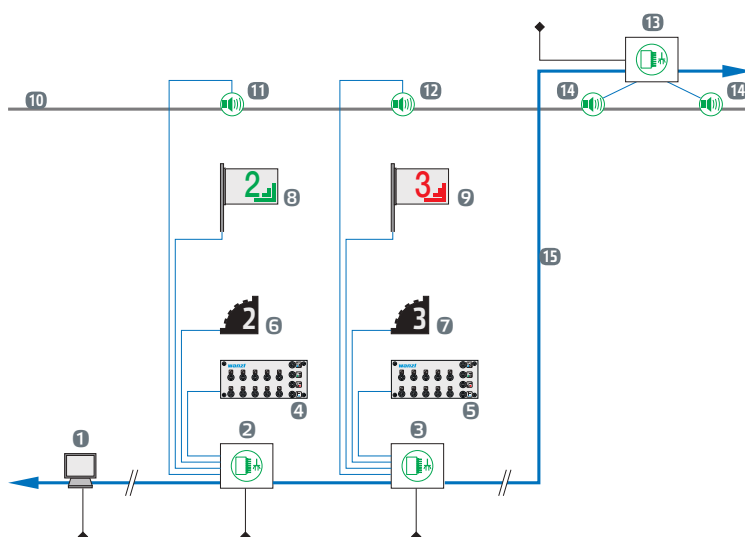

Detailed checkout connection

- 1 Branch manager display
- 2 Checkout 2 control unit
- 3 Checkout 3 control unit
- 4 Checkout 2 control panel
- 5 Checkout 3 control panel
- 6 Optional checkout connection for checkout 2
- 7 Optional checkout connection for checkout 3
- 8 Checkout 2 display
- 9 Checkout 3 display
- 10 Ceiling
- 11 Checkout 2 loudspeaker
- 12 Checkout 3 loudspeaker
- 13 Loudspeaker control unit
- 14 Store loudspeaker
- 15 Bus line
- Control unit
- Loudspeaker
- ↓ 230 V AC socket

07.05 Swivel range monitoring/retrofitting



Added security

Protects persons, and especially children, from possible injuries. In the exit section, integrated light barriers detect obstacles in the swinging area and stop the movement of the swivel barrier.

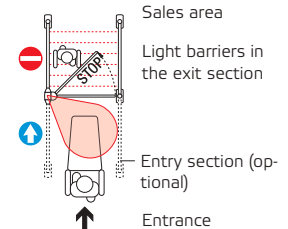

Swivel range monitoring for eGate, eGate Colour and Technoport in the exit/intermediate section			
Swivel barrier used	Prod.No.*	Connecting tube with light barrier	Connecting tube with reflecting mirror
Length (mm)		Length (mm)	Length (mm)
Technoport single systems			
850	23.73672.09/10/73	1100	1135
980	23.73671.09/10/73	1100	1135
980	23.91531.09/10/73	1500	1535
eGate and eGate Colour single systems			
850	23.20700.09/10/73	1100	1195
850	23.00714.09/10/73	1500	1595
980	23.57425.09/10/73	1100	1195
eGate, eGate-Colour and Technoport double system			
680	23.47594.09/10/73 upon request	1100	1100
850	23.47707.09/10/73	1100	1100
850	23.75711.09/10/73	1500	1500
980	23.39550.09/10/73	1100	1100
980	23.37969.09/10/73	1500	1500
1200	23.51549.09/10/73 upon request	1500	1500

Cross connections for swivel range monitoring safety connection

Note: Only for double and double 2-gate systems

4 m	Prod.No. 98.73391.00	22 m	Prod.No. 98.73650.00
10 m	Prod.No. 98.73392.00	28 m	Prod.No. 98.04069.00
16 m	Prod.No. 98.73649.00		

* Info: If retrofitting the swivel range monitoring, a light version is used. There is no detection between the uprights. Fully integrated swivel range monitoring is available on request. Retrofit for existing exit section without sleeves or bases. For the power supply, sleeves with a hollow screw with a diameter of 16.5 mm are required. Not for systems prior to 07/2014.

07.06 Individual parts

Connection sleeves for connecting tubes with 40 mm diameters			Half sleeves for connecting tubes with 40 mm diameters				
Material	Plastic		Material	Metal			
Fits	Base diameter 50 mm	Base diameter 60 mm	Fits	Base diameter 50 mm	Fixture for half sleeve		
Prod.No.	23.04015.07	23.04973.07	Prod.No.	23.17654.10/73	23.85035.10/73		
1 unit with fixing material			1 unit with fixing material				
Connection sleeves for connecting tubes with 40 mm diameters							Bushing
Material	Metal						Metal
Fits	Base diameter 50 mm	Base diameter 60 mm	Base diameter 120 mm	mGate	eGate portrait	eGate landscape	on 90° connecting tube
Prod.No.	23.07105.10/73 23.83968.09	23.07104.10/73 23.18308.09	23.09571.10/73/09	23.55293.10/73	23.78325.10/73	23.03976.10/73	23.09965.10/73 00.98835.09
1 unit with fixing material							
Wall mounts, for connecting tubes with 40 mm diameters			Wall mounts, for connecting tubes with 40 mm diameters				
Material	Plastic	Metal	Material	Metal			
Fits	Straight walls	Straight walls	Fits	Cash desks			
Prod.No.	23.05242.07	23.40110.10/73/09	Prod.No.	23.07107.10/73			
1 unit with screw and dowel			1 unit with screw and nut				
Tube end cap							
Material	Plastic						
Fits	Tube with 32 mm diameter	Tube with 40 mm diameter	Tube with 50 mm diameter	Tube with 60 mm diameter			
Prod.No.	23.06498.07	23.06497.07	23.04014.07	23.08235.07			
1 unit							
Base plate covers			Set collar				
Material	Metal		Material	Metal			
Fits	Base diameter 50 mm	Base diameter 60 mm	Fits	Base diameter 50 mm	Threaded pin for set collar		
Prod.No.	23.10642.10/73/09	23.04984.10/73/09	Prod.No.	00.01992.10	90.11494.50		
1 unit			1 unit with 3 threaded pins		 For replacement needs		

Order tip:

23.04015.07
23.09571.10
23.09571.50
23.09571.73
23.09571.09

Plastic
Metallic high-gloss chrome-plated
Metallic high-gloss galvanised
Metallic plastic powder-coated, please specify colour required.
Stainless steel





07.07 Fixing material

Fixing material for protection systems, barrier works, customer guidance systems, etc. for normal floor construction				
<p>Hexagonal screw Dowel</p>	Hexagonal screw	M10x60, galvanised	M10x60, stainless steel	
	Prod.No. (for 1 unit)	90.11274.50	90.11274.09	
<p>Hexagon socket screw Dowel</p>	Hexagon socket screw	M10x60, galvanised	M10x60, stainless steel	
	Prod.No. (for 1 unit)	90.11470.50	90.11470.09	
<p>Dowel</p>	Dowel	M10		
	Prod.No. (for 1 unit)	91.07196.00		
<p>Hexagonal screw Spacer tube</p>	Hexagonal screw	M10x100	M10x120	M10x150
	Prod.No. (for 1 unit)	90.11605.50	90.11277.50	90.11278.50
<p>Hexagon socket screw Spacer tube</p>	Hexagon socket screw	M10x100	M10x120	M10x150
	Prod.No. (for 1 unit)	90.11634.50-0000	90.11832.50-0000	90.11833.50-0000
<p>Spacer tube</p>	Spacer tube	40 mm	60 mm	90 mm
	Prod.No. (for 1 unit)	00.07446.00	00.07447.00	00.07448.00
<p>Dowel</p>	Dowel	M10	M10	M10
	Prod.No. (for 1 unit)	91.07196.00	91.07196.00	91.07196.00



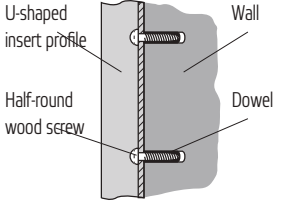

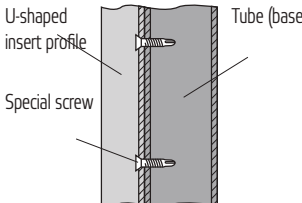
Optional: Fixing with adhesive technology with threaded bolt for various floor compositions	
<p>Threaded bolt Nut with washer Adhesive</p>	Fixing set
	Prod.No. (for 1 unit)
	Set complete for eGate, checkout barriers, partitions, etc.
	Prod.No. (for 1 unit)
	Adhesive for fixing set
	Prod.No. (for 1 unit)
Two fixing sets (8 bore holes) can be mounted with one cartridge	

Note: With underfloor heating specify the maximum permitted bore depth. Entrance system uprights are delivered as standard with fixing material.

07.07 Fixing material

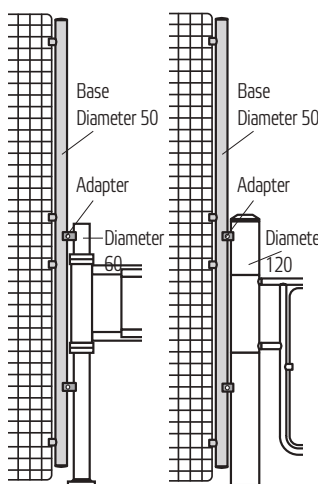
 <p>U-shaped insert profile</p> <p>Wall</p> <p>Half-round wood screw</p> <p>Dowel</p>	Fixing material for Railix U-shaped insert profile for wall mounting	
	Set 6 units half-round wood screws 3.5x35 DIN 96 zn, 6 units 5 mm dowels Prod.No. 23.20126.00-0000 for standard fixing Half-round wood screw galvanised surface Plastic dowel	
 <p>U-shaped insert profile</p> <p>Tube (base)</p> <p>Special screw</p>	for fixing to base with a height of 2000 mm	
	Set 7 special screws Sp3/22-6, 8-M3.9x28 GSW Prod.No. 77.10951.00-0000 Self-threading screws	 <p>Note: Bases screws up to a height of 1500 mm 5x, up to a height of 1750 mm 6x and up to a height of 2000 mm 7x</p>

07.08 Special bases

 <p>Base Diameter 50</p> <p>Adapter</p> <p>Diameter 60</p> <p>Diameter 120</p>	Bases without base plates for space-saving connection to barriers and entrance systems suitable for Classic partition system with height 2000 mm		
	Prod.No. (for 1 unit) 77.61711.10-0000 Tube diameter 50 mm, height 1890 mm High-gloss chrome-plated finish		
	Tube adapter Aluminium	Diameter of 50 to 60 mm Prod.No. (for 1 unit) 77.71062.44-0000	Diameter of 50 to 120 mm Prod.No. (for 1 unit) 00.20657.44-0000
			

Note: Only when ordering new, retrofit not possible

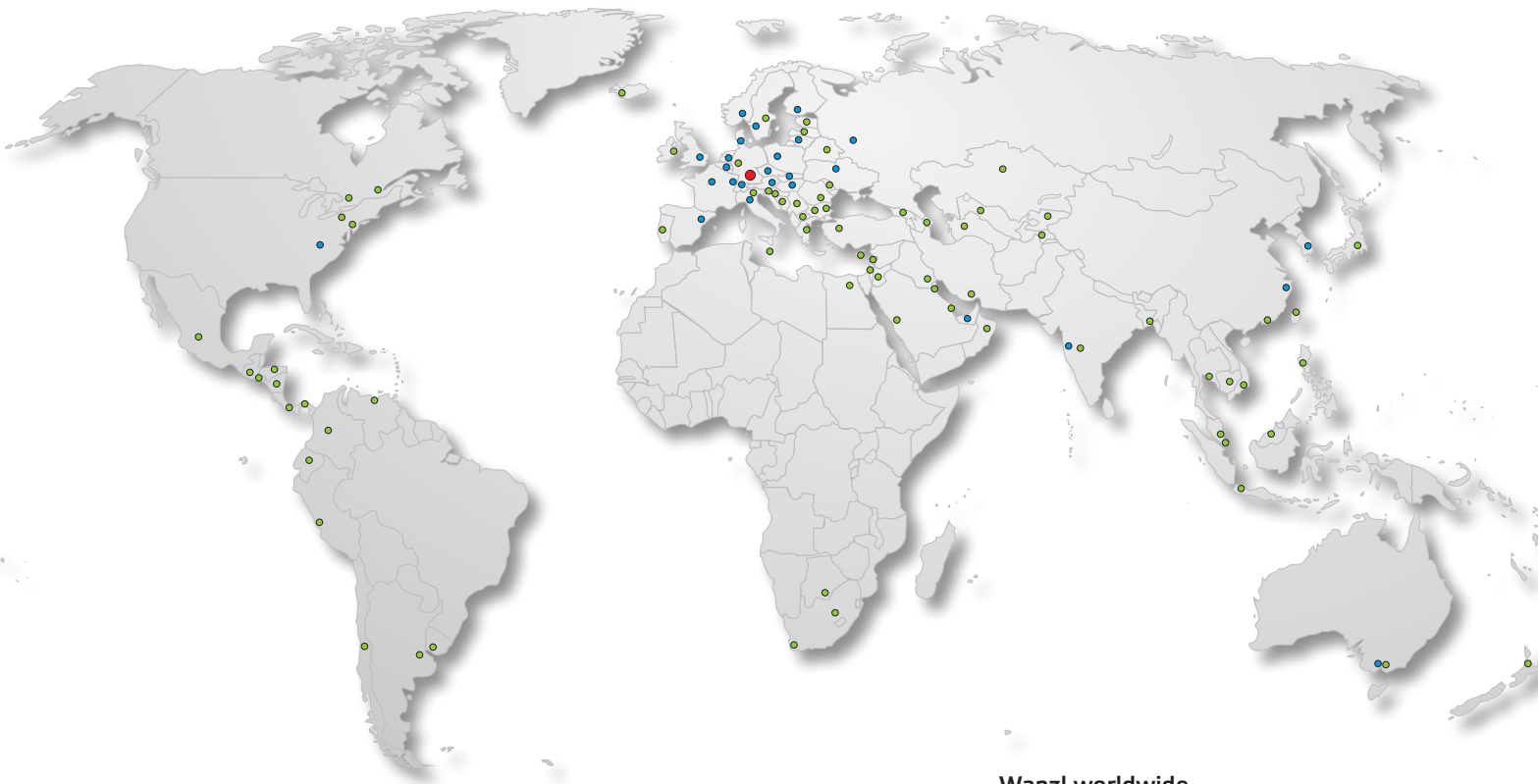

Wanzl worldwide

- Head Office
- Subsidiaries
- Partners



GERMANY

Wanzl GmbH & Co. KGaA
Rudolf-Wanzl-Straße 4
89340 Leipheim

Phone +49 (0) 82 21 / 7 29-0
Fax +49 (0) 82 21 / 7 29-1000

info@wanzl.com
www.wanzl.com

GREAT BRITAIN

Wanzl Ltd.
Europa House
Heathcote Lane
Warwick CV34 6SP

Phone +44 (0) 1926 / 45 1951
Fax +44 (0) 1926 / 45 1952

enquiries@wanzl.co.uk
www.wanzl.com

AUSTRALIA

Wanzl Australia Pty. Ltd.
97 Highbury Road
BURWOOD VIC 3125

Phone +61 (0) 3 / 98 08 22 99
Fax +61 (0) 3 / 98 08 22 66

info.au@wanzl.com
www.wanzl.com